

## INSTALLATION GUIDELINES

These instructions have been compiled as a result of long-standing experience gained by CORIALIS Group's staff and practice applied by many installation groups. The objective is to explain and clarify how window and door joinery (in particular structures of larger dimensions and higher weight) should be installed.

The instructions draw attention to individual types of installation, installation steps and available options. This quick guide also presents how to avoid basic errors during installation and sealing of joinery in the building.

These instructions include guidelines relating to:

1. Warnings and general information
2. Preparation and measurement of the opening in the wall
3. Installation procedures
4. Sealing and thermal insulation
5. Inspection and functional check

### 1. Warnings and general information

The figures presented in these instructions show solely and exclusively suggested installation solutions for individual structural solutions in different types of walls. Every installation project must be preceded by calculations and installation details to the approved by competent decision-making bodies. While referring to the instructions, bear in mind that joinery must not be a structural component of the building. (Joinery constitutes only building filling!)

In special cases, wherein structures are made of profiles featuring thermal cavities of large overall dimensions, adverse bending of leaf profiles can occur.

Such situations may occur due to the following factors:

- dark colour of the joinery
- structure installed on the southern side or southern-western side of the building
- structure exposed to direct sunlight (no guard in the form of the roofing, awning, guarding enclosures or trees)
- structure filling in a dark colour
- long tie beams in the door leaf.

Such bending is caused by non-uniform elongation of the internal and external shapes of the leaf profile due to temperature difference. The effect intensifies together with better insulation of profiles with thermal cavities, compared to those featuring worse insulation. The higher difference in the temperature is, the more extensive bending of the profiles becomes. The effect disappears when the temperatures equalise, i.e. at the end of the day. By analogy, in the event of a considerable drop in temperature of the external shape, such bending has the reverse effect.

To avoid the situation, one of the listed factors having an impact of the structure must be eliminated, overall dimensions of door leaves must be reduced or shapes with Bi-Metal insulation must be applied (e.g. UG820BM should be used instead of UG820).

## 2. Preparation and measurement of the opening in the wall

Prior to installation and mounting of window structures, one must check:

- dimensional compliance of the window openings being prepared with that documentation, and the arrangement of the lower opening edge relative to the ground level and levels of benchmarks
- arrangement of wall thermal insulation
- arrangement of (internal and external) window sills
- conditions under which the windows are installed if the building facade is made of flagstones or other slabs.

The above actions are the basis for determination of window dimensions and the manner of installation.

In order to determine the window external dimension properly, it is essential to check diagonals of the window opening. Limit dimensional deviations for diagonals of window openings are presented in the following table.

Opening dimensions	100mm - 500mm	501mm - 1000mm	1001mm - 3000mm	3001mm - 6000mm
Deviation	± 3 mm	± 6 mm	± 8 mm	± 12 mm

See the following figure to determine properly the dimension of height and width of the window opening in the reveal.

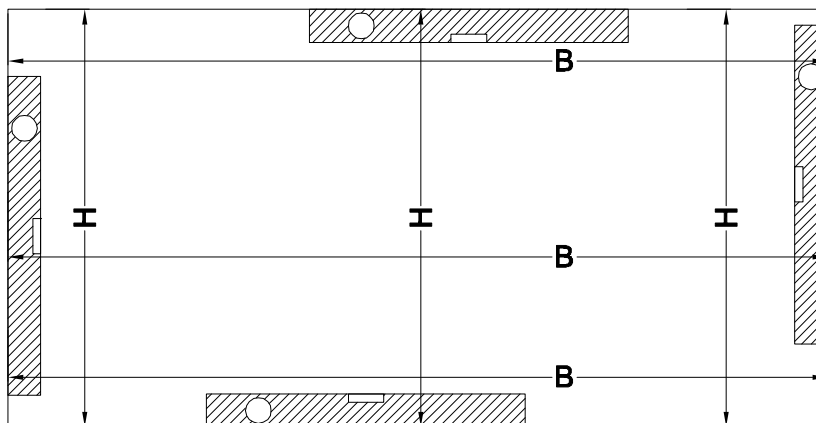

**3. Installation procedures**

Window-door structures should be installed within the plane which is parallel to the building wall, with the verticality and horizontality maintained.

Window arrangement the opening of a new building must comply with the design and technical documentation and located in the reveal, partially or completely protruding so that linear thermal bridges can be minimised. Windows protruding from the wall face are applied in energy-saving or passive buildings. The occurrence of such bridges results in condensation of water vapour on the internal side of the frame, reveal surface or inside the window-wall joint.

For windows protruding from the wall face, system solutions using wall consoles, brackets, angle sections or load-carrying frames are used. Windows should be located within the layer of building thermal insulation.

If the reveals are provided with jambs, it is recommended to position the window so that (vertical and horizontal) frame profiles are covered by the jamb by no more than the half width of the frame shape to avoid any conflict with window functioning.

Windows are positioned using support and spacer blocks. The arrangement varies depending on the type, size and opening the mode of window opening. The following figures present the arrangement principle.

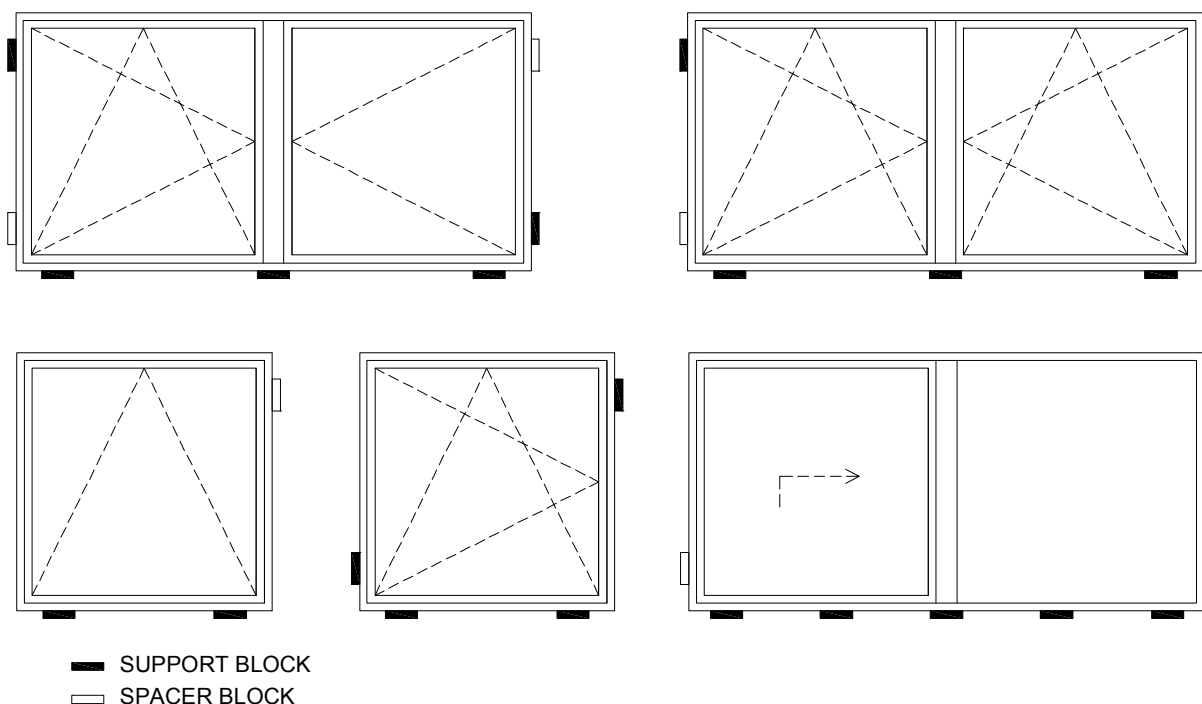

The support and spacer blocks should be made of impregnated hardwood, plastics, aluminium or steel protected from corrosion.

The support and spacer blocks should be spaced so that frames cannot be deformed due to temperature and the window weight and affected by the risk of functional deterioration.

The support blocks should be spaced in the centre below vertical elements of the frame and mullions (including movable mullions). If the arrangement is different, it may cause considerable bending of the lower profile of the frame due to window weight. For sliding or tilt sliding balcony doors, the lower part of the frame must be stably supported along the entire length by the use of a continuous support beam or provision of support blocks (together with consoles if the door protrudes from the wall face) under the guide rail, with the maximum distances between such items being up to 400 mm.

The support blocks are not used for installation of windows protruding from the wall face and located within the thermal insulation layer. The spacer blocks, which are used during installation for temporary positioning of the window in the opening, should be moved inwards once the frame is mounted in the opening. However, the support blocks must not be removed. Wedges or pads used during installation or positioning the window do not serve as support blocks!!!

Installation of windows using only dowels, screws or anchors without support blocks is insufficient to transfer loads occurring within the plane of the window or the balcony door.

Allowable vertical and horizontal deviations relating to the position of the window in the opening for the element length up to 3 m is 1.5 mm, but no more than 3 mm.

The minimum dimensions of gaps between the frame and the reveal are presented in the following table. If filling in the form of impregnated expandable tapes is used, the following values can be reduced by 50%.

Element length	100mm - 1500mm	1501mm - 2500mm	2501mm - 3500mm	3501mm - 4500mm
Min. width of gaps	10 mm	15 mm	20 mm	25 mm

The maximum dimension of the gap between the frame and the reveal should not exceed 40 mm. In special cases, larger dimensions are allowable but the manner of sealing and application of materials require a separate solution.

Any type of single-purpose and multi-purpose tapes and films must be applied according to the guidelines provided by the manufacturer of such products as well as requirements relating to the preparation of the surfaces to be glued. Wide expandable tapes should be installed within the entire installation depth.

Mechanical installation of windows directly or indirectly (using anchors) in the wall.

All mounting elements should be protected from corrosion or be made of a material which is resistant to humidity and weather conditions. In order to mount the frame, elements selected accordingly to loads, which may be exerted on the window or the wall material, are used.

Each single time, the selection of mounting elements should be adapted to the material used to make the wall, which should be envisaged in the window installation design in advance.

Direct mounting in the form of the dowel bar/expansion plug and mounting the anchor/bracket to the wall should be carried at a distance of at least 60 mm from the wall edge.

Expansion plugs/dowel bars should be used only and exclusively for vertical and upper elements in frames of sliding systems, whereas anchors such as ACVL130 / ACUN23X may be spaced around the frame parameter.

If anchors are used, the mutual distance cannot exceed 400 mm.

Mounting windows partially or completely protruding from the wall face may involve consoles and brackets or steel angle sections. Such elements should be selected accordingly to transfer external loads exerted on the window and occurring due to the window weight.

Arrangement of such elements and the fastening is presented in the figure provided hereinafter in this handbook.

System solutions comprising lower consoles, side and upper brackets for fastening windows protruding from the wall face should be used according to guidelines and to the extent specified by the manufacturer. The console is an element on which the window is mounted with all its weight. It may be simultaneously used as the support block and the fastening point. The side and upper brackets are elements which transfer loads exerted by wind and loads associated with movement of leaves to the wall structure.

The following figure presents a diagram of an example lower console for the UG812 shape (protruding from the wall face) together with the UG1810 under-sill profile. Additionally, there is the GT010 shape together with PVC502 and PVC503 under-sill profiles.

The under-sill profile in this case provides stiffness of the frame and makes it possible to attach the lower console directly to the shape. Such a solution simultaneously ensures drainage tightness (no openings are made in the frame profile) as well as stiffness in each direction of the forces exerting loads on the lower section of the frame.

The following diagram shows the manner of correcting the frame installation height, frame depth relative to the wall face and corrections (if any) when the frame is screwed along the profile axis (difference in the height of paths at the frame).

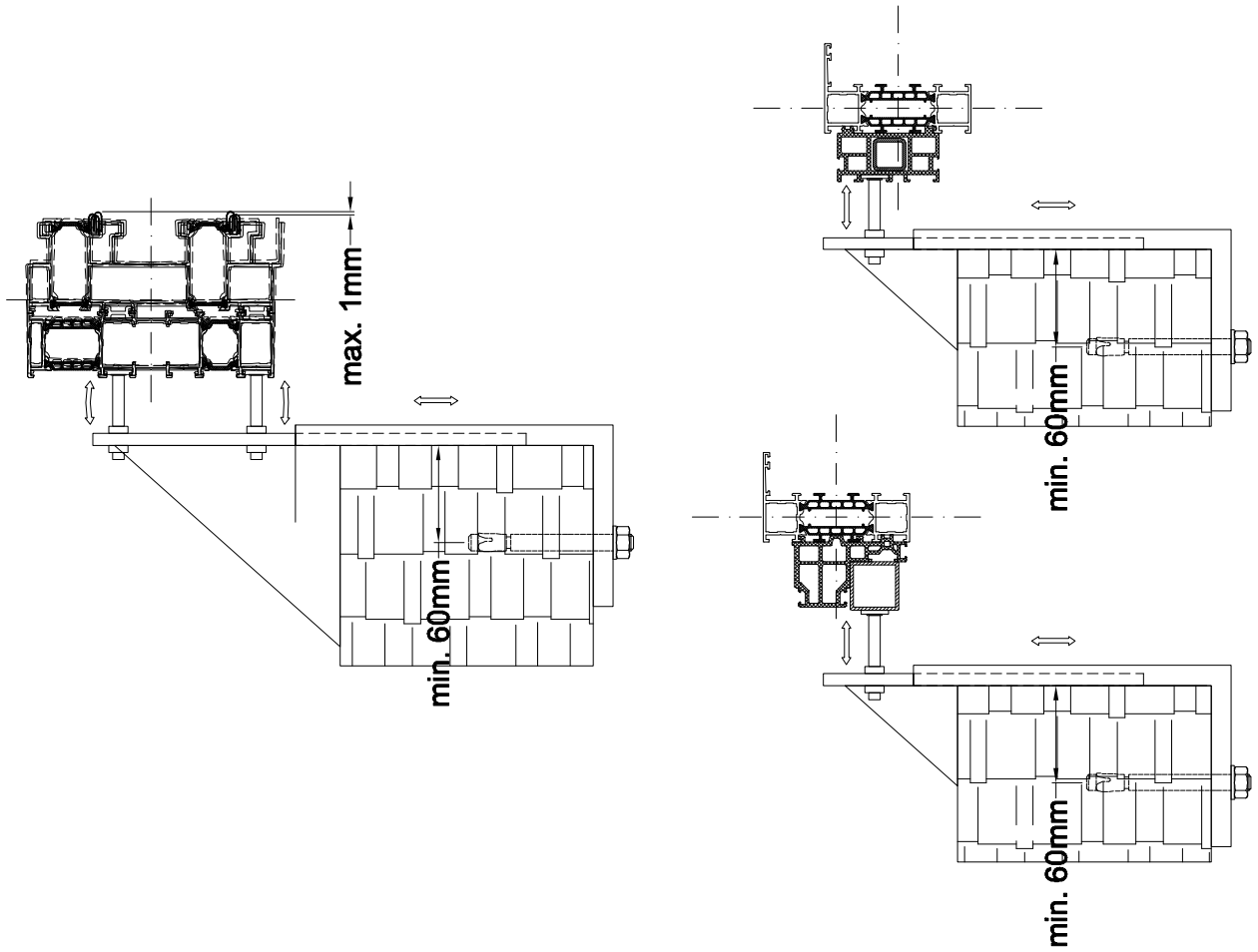

INSTALLATION GUIDELINES

While designing window fastening, an expansion joint of both the building and the structure must be taken into account. The accepted principles for aluminium state that expansion of a 1000 mm long profile by 1 mm when cooled in winter and heated in summer. The structure expansion is provided by special joints of two structures. However, if there is just one structure, the length of which exceeds 6000 mm, the expansion joint must be provided at anchors or mounting brackets

## 4. Sealing and thermal insulation

Sealing and thermal insulation of the joint between the window and the wall should consist of 3 layers as follows:

- internal layer made of vapour-proof materials in the form of various types of tapes and films which do not allow air and water vapour to permeate;
- midpoint layer which provides thermal and acoustic insulation between the window and the wall, made of polyurethane foam or mineral wool, preventing condensation of water vapour in the gap with the thermal insulation. (it must be remembered that polyurethane foams and other similar insulation materials are not used for window installation);
- external layer which provides sealing, made of impregnated expandable tapes or vapour permeable films.

It is allowed to use packing materials which simultaneously have two or three of the listed functions provided that the properties are documented for the particular case by the manufacturer.

While sealing, always follow the general rule which says that the item must be tighter on the internal side than on the external side.

Remember that window installation without sealing and installation of with all three layers is incorrect as no tightness of the joint and performance of the thermal and acoustic insulation can be provided.

The external sill should protrude from the plane of the wall by approx. 30 to 40 mm, but no less than 20 mm. The sill collar must be inserted under the lower part of the frame, and the place of joint must be permanently sealed using a flexible sealant. Additionally, if the sill is attached to the under-window profile using screws, the screw heads must be sealed too. The sill joint in the corner (along the length or with the reveal) should be provided with continuous sealing. The sill must be fitted with an expansion joint approx. at every 2.5 m and protected from being pulled off by wind. The proper support and installation will result in dampening of the noise of rain. End caps at the sill must be selected accordingly to the applied facade solution.

The inner sill should be mounted in the lower part of the window once sealing on the internal side of the contact between the frame with the reveal is provided.

For sealing and insulating the structure joint with the wall, the elements offered by Aliplast Sp. z o.o. can be used.

Depending on the system of the structure, it is possible to apply the following flap seals

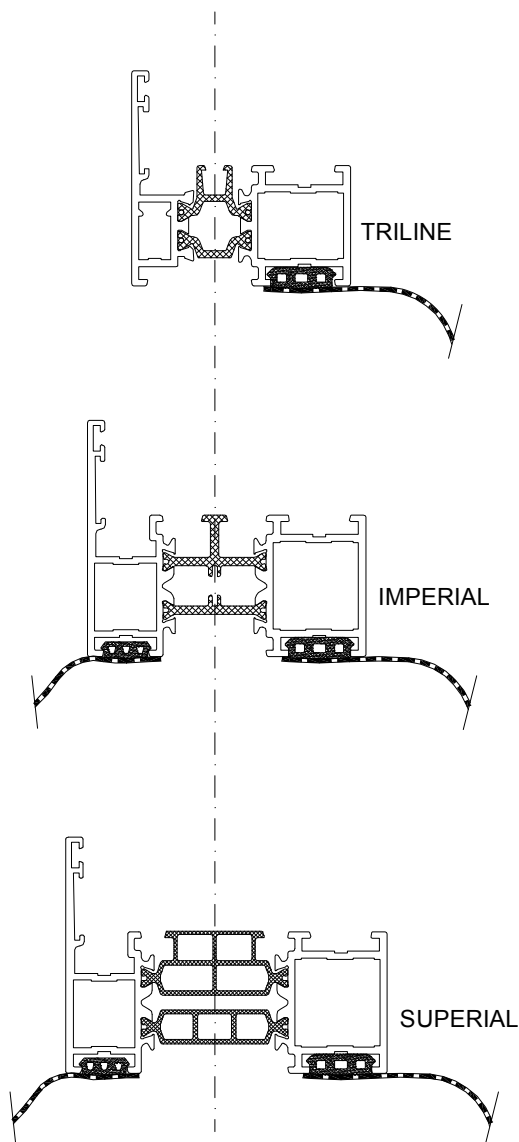

**VAPOUR PERMEABLE FLAP SEAL**

**- EXTERNAL SIDE**

- ACIP180 - wpinka zewn. + fartuch 150mm
- ACIP181 - wpinka zewn. + fartuch 200mm
- ACIP182 - wpinka zewn. + fartuch 250mm
- ACIP183 - wpinka zewn. + fartuch 300mm

**VAPOUR-PROOF FLAP SEALS**

**- INTERNAL SIDE**

- ACIP190 - wpinka wewn.+fartuch 150mm
- ACIP191 - wpinka wewn.+fartuch 200mm
- ACIP192 - wpinka wewn.+fartuch 250mm
- ACIP193 - wpinka wewn.+fartuch 300mm



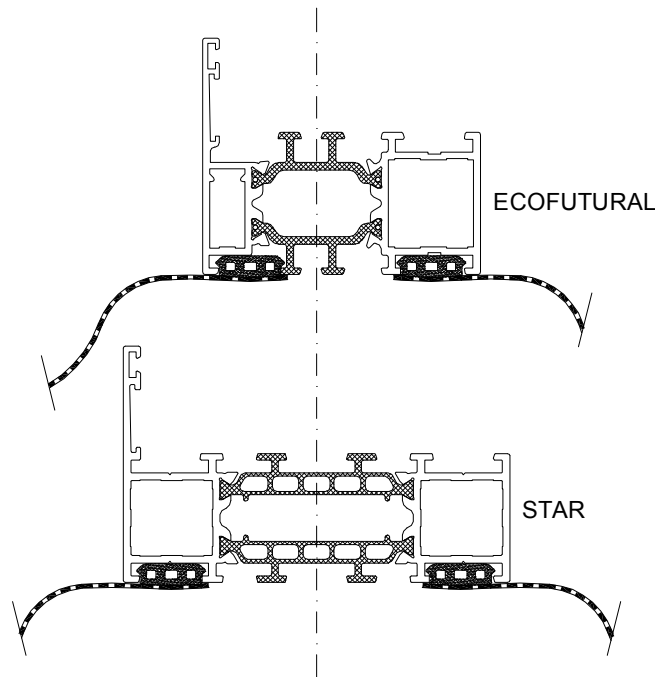

**VAPOUR PERMEABLE FLAP SEAL**

- EXTERNAL SIDE

- ACEF180 - wpinka zewn. + fartuch 150mm
- ACEF181 - wpinka zewn. + fartuch 200mm
- ACEF182 - wpinka zewn. + fartuch 250mm
- ACEF183 - wpinka zewn. + fartuch 300mm

**VAPOUR-PROOF FLAP SEALS**

- INTERNAL SIDE

- ACEF190 - wpinka wewn.+fartuch 150mm
- ACEF191 - wpinka wewn.+fartuch 200mm
- ACEF192 - wpinka wewn.+fartuch 250mm
- ACEF193 - wpinka wewn.+fartuch 300mm

## 5. Inspection and functional check

Once mounted, the inspection of windows and balcony doors should involve checking for proper installation and functionality, and the following requirements should be met:

- vertical and horizontal deviations cannot exceed 1.5 mm for an element the length of which is up to 3 m;
- difference in the length of diagonals of the frame and the leaf should not exceed:
  - 2 mm if the element is up to 2 m long
  - 3 mm if the element is longer than 2 m
- once opened, the leaf should not close or open itself by its own weight;
- once closed, the leaf should adhere uniformly to the frame, ensuring tightness between such elements;
- deformation of frames should not exceed 1 mm per 1 m;
- change in shape and dimensions of windows and balcony doors should not significantly impair their operation, require hardware replacement; additionally, no damage to window elements, i.e. no damage to hardware, seals, frames, hardware corrosion, etc. should be caused.

Any deformation must be measured when the leaves are close without the hardware bolted.

PVC502

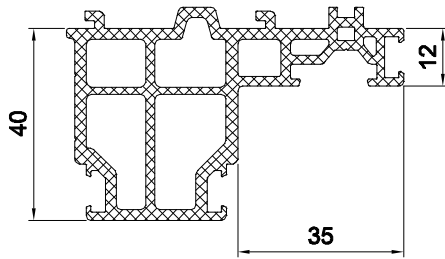

PVC503

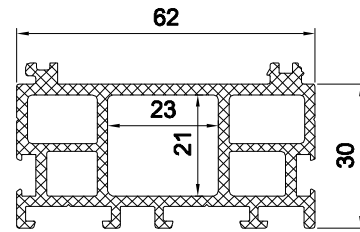

UG1611

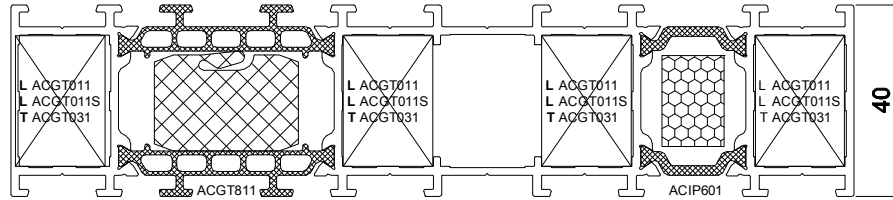

UG1810

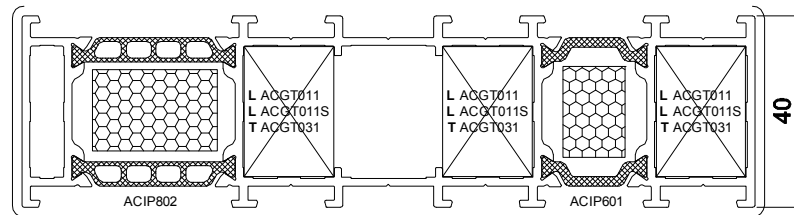

UG1212

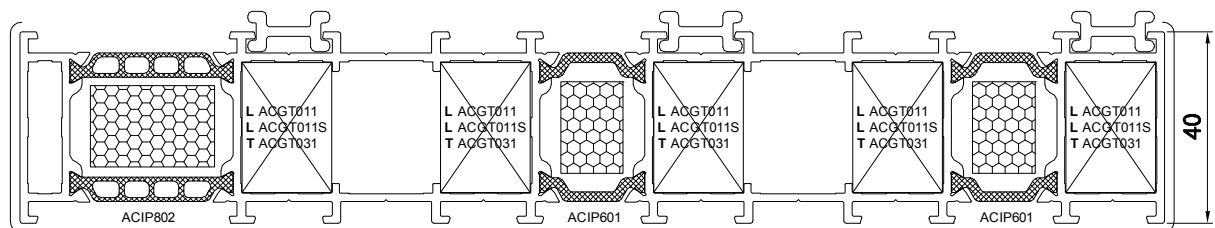

INSTALLATION GUIDELINES

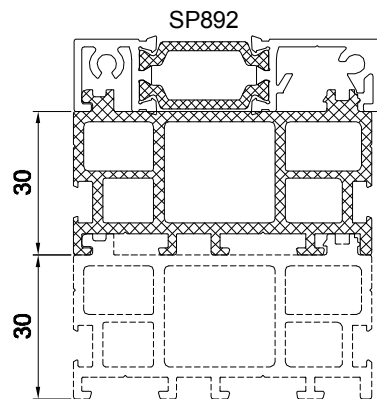
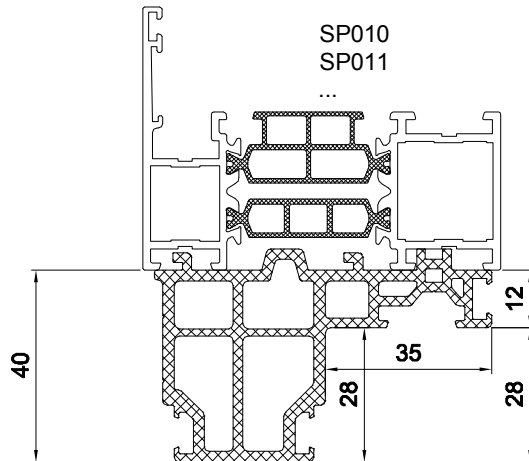
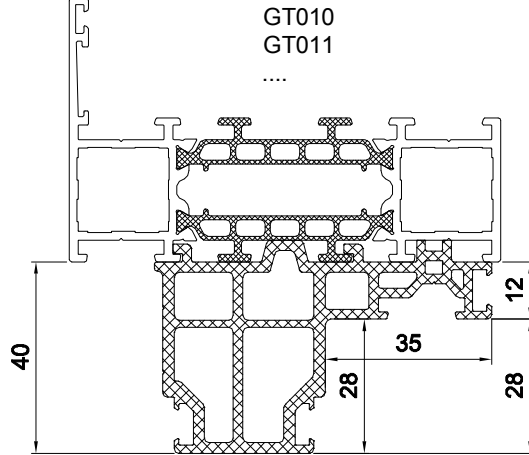
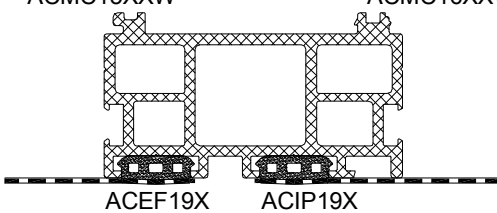
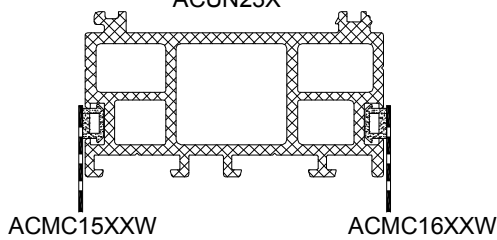
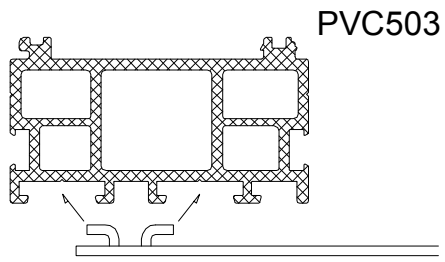
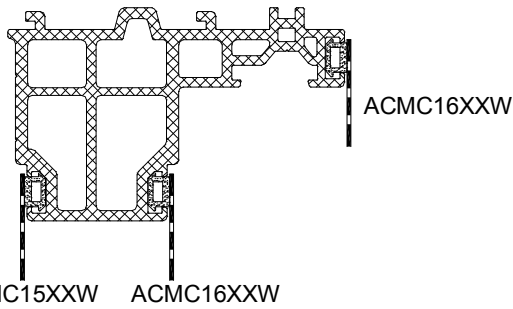
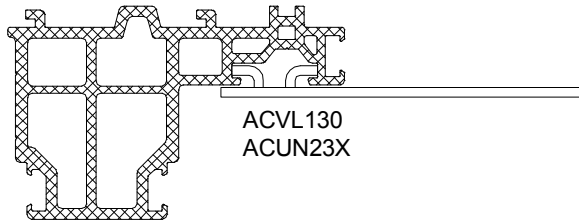
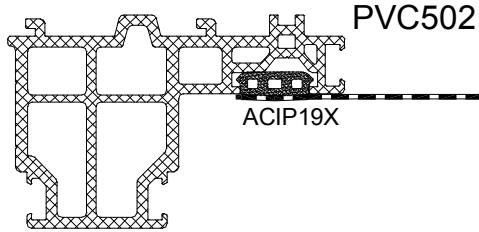

installation\_14\_06\_2017\_en

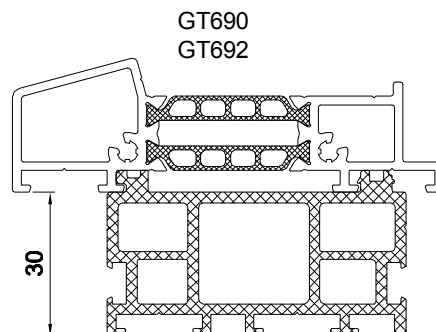
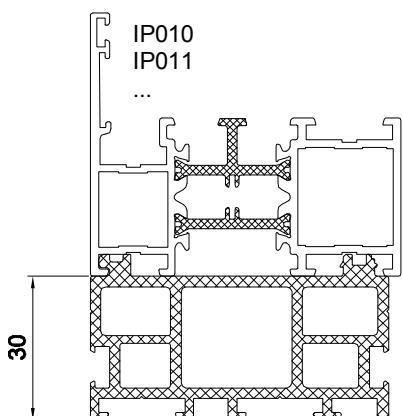
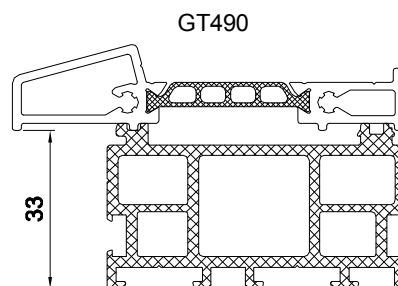
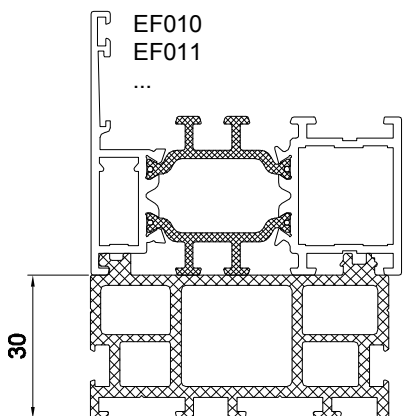
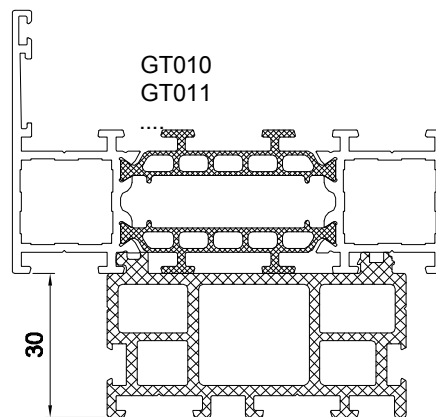
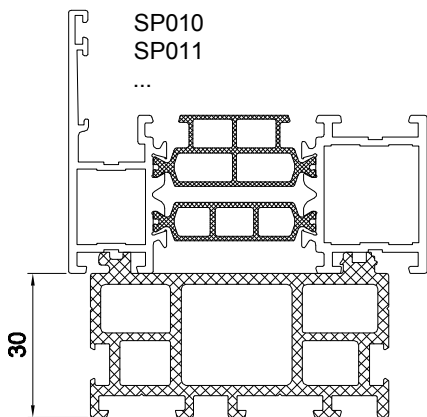

INSTALLATION GUIDELINES

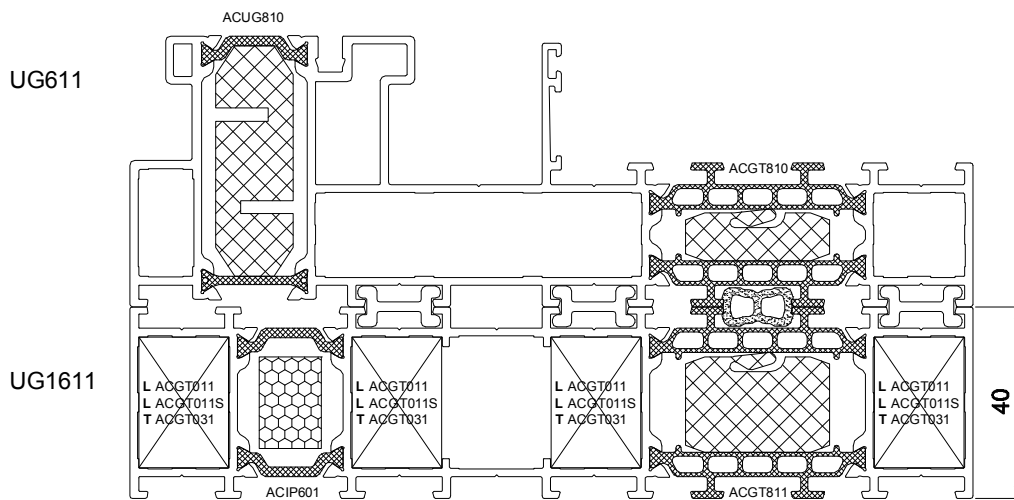
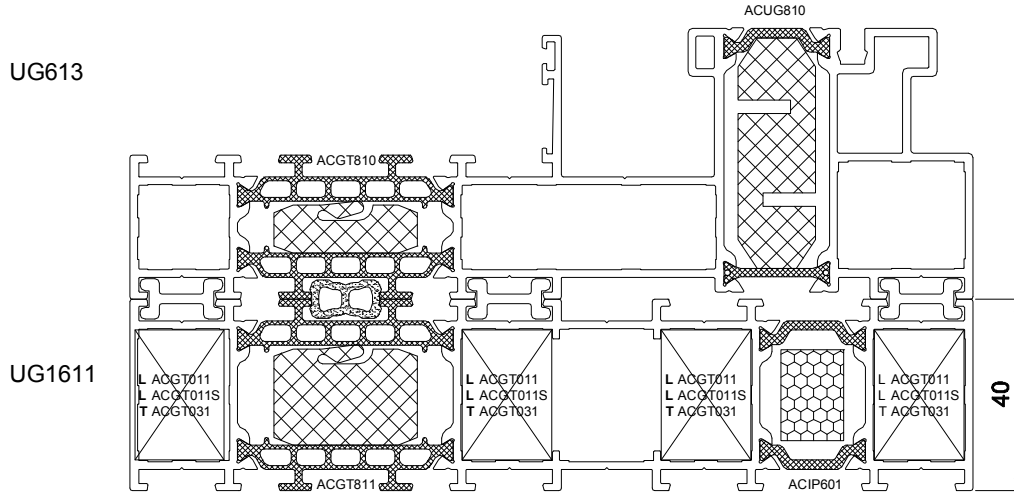

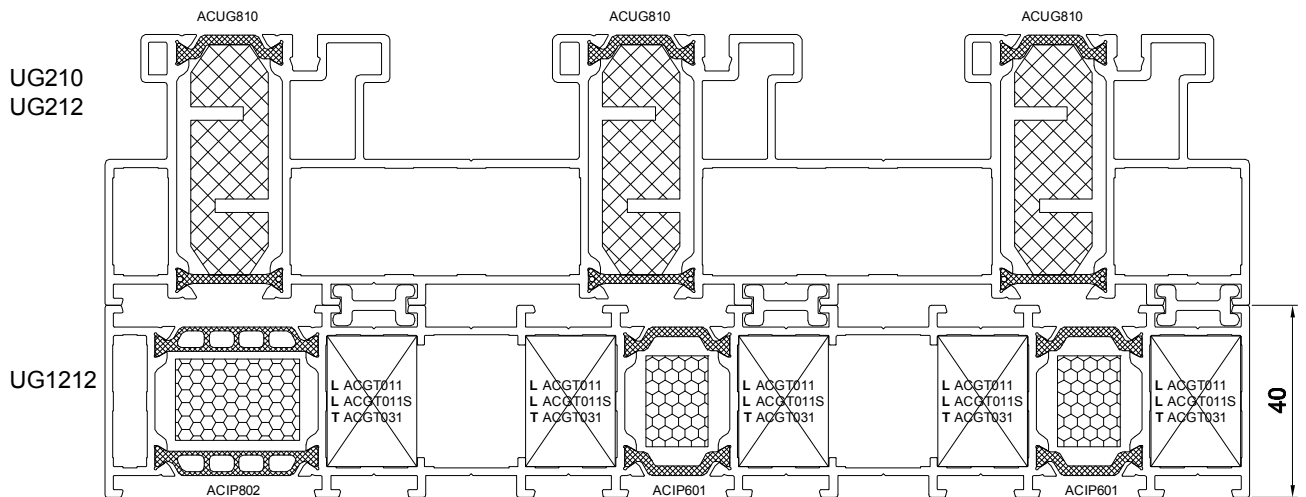
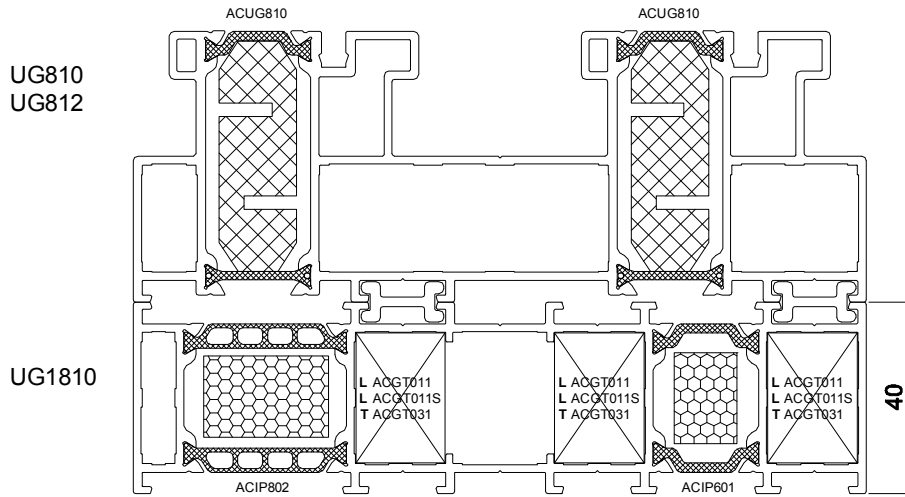

INSTALLATION GUIDELINES

installation\_14\_06\_2017\_en

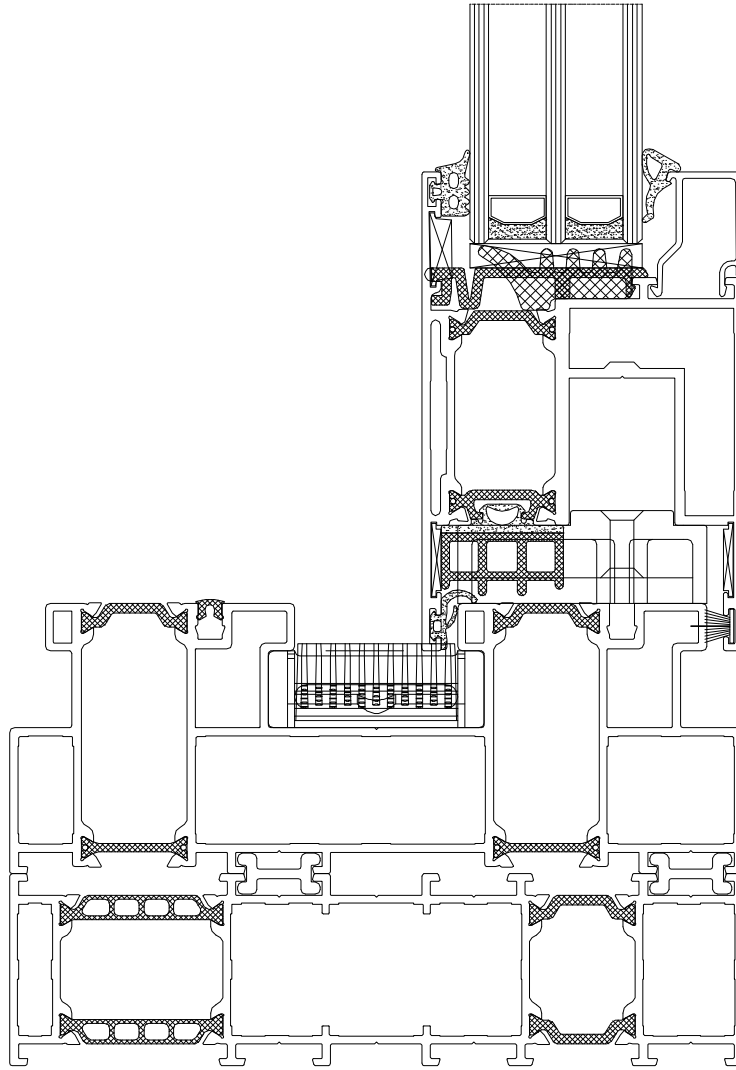

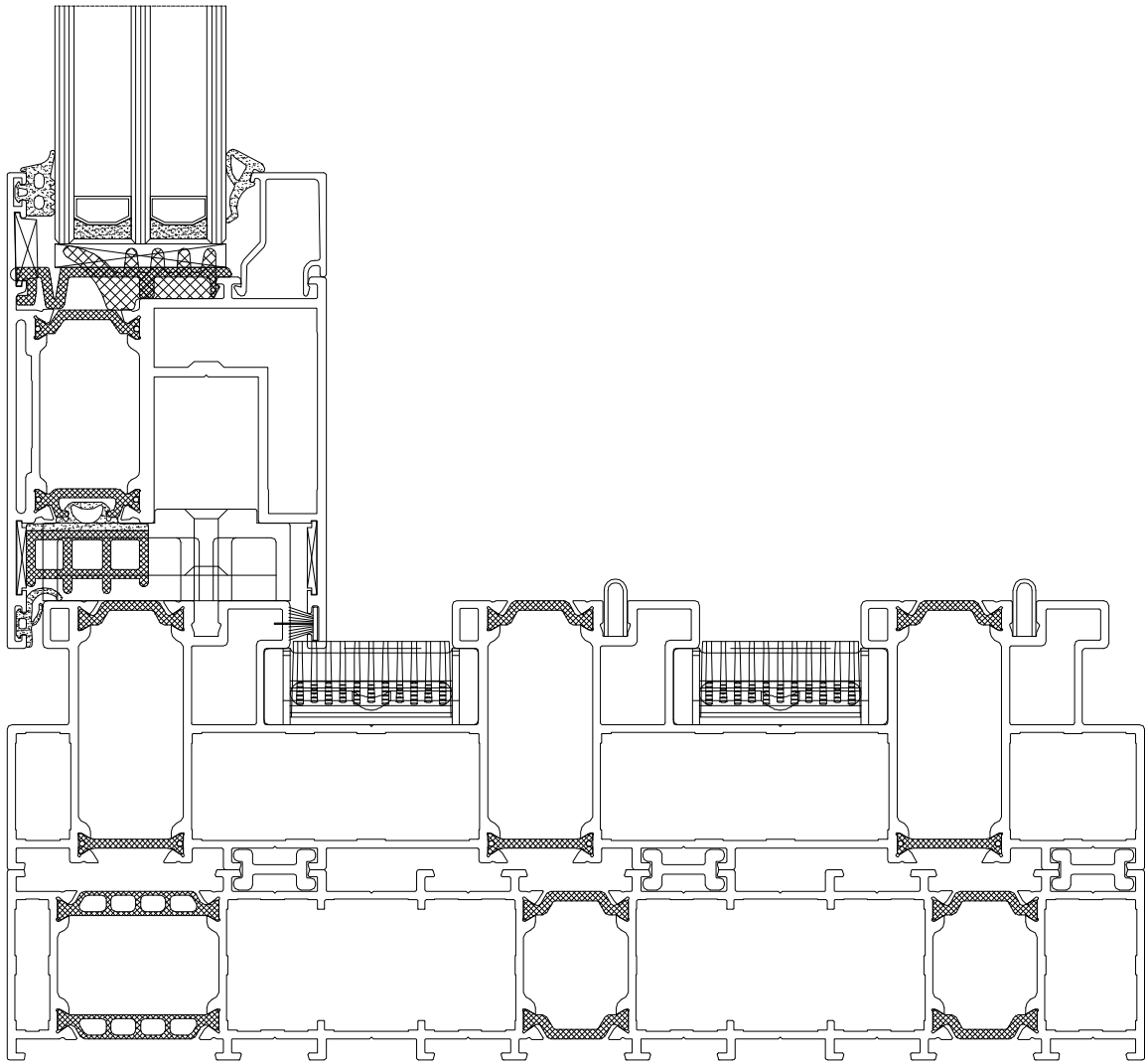

INSTALLATION GUIDELINES



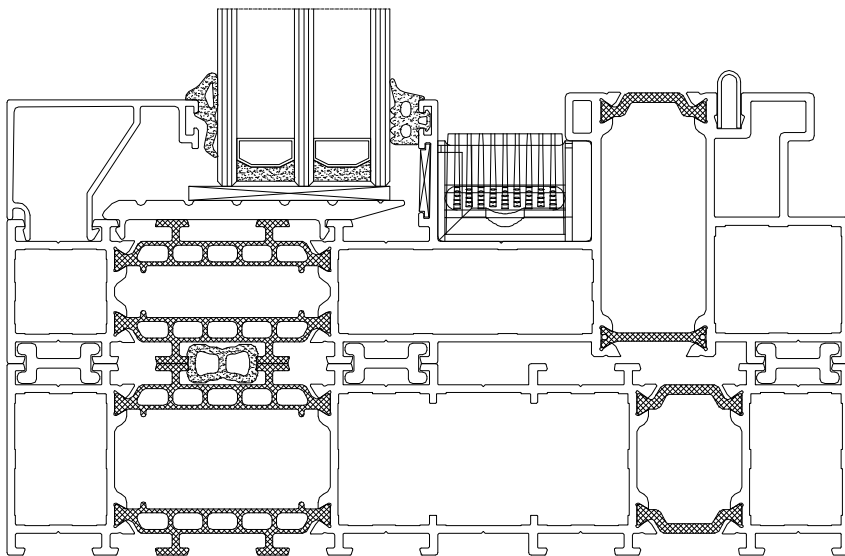
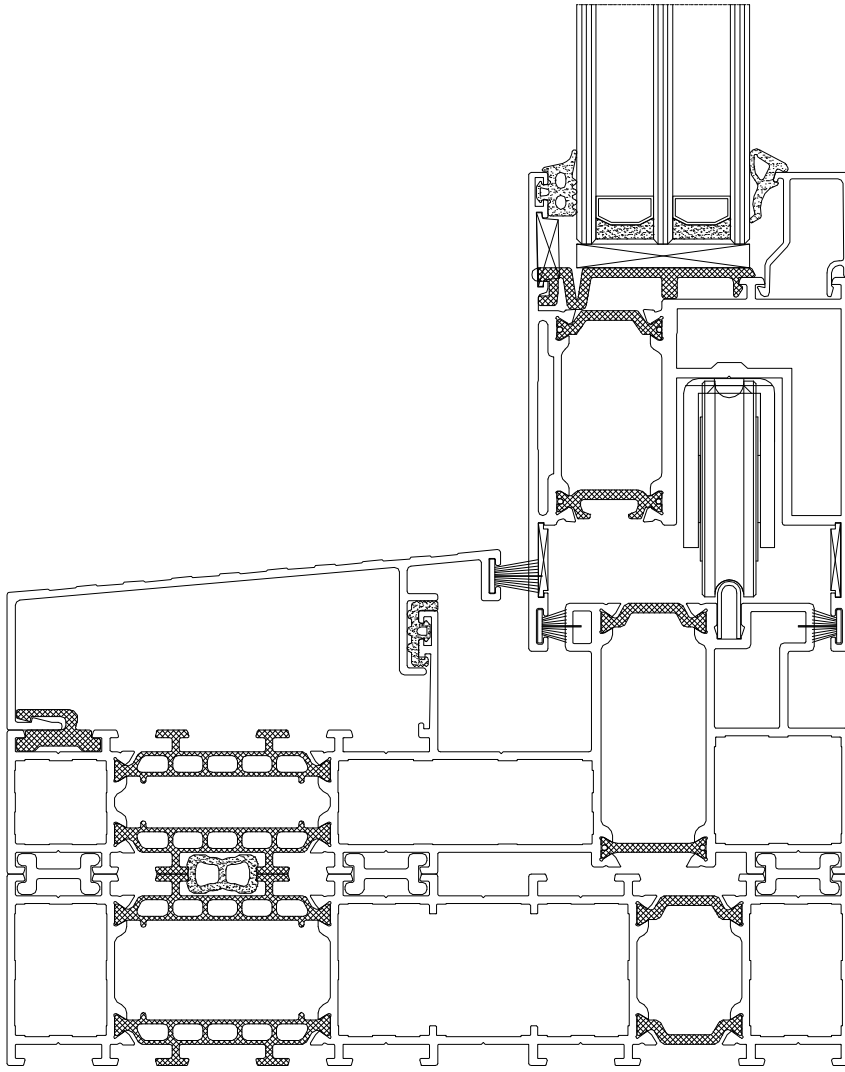

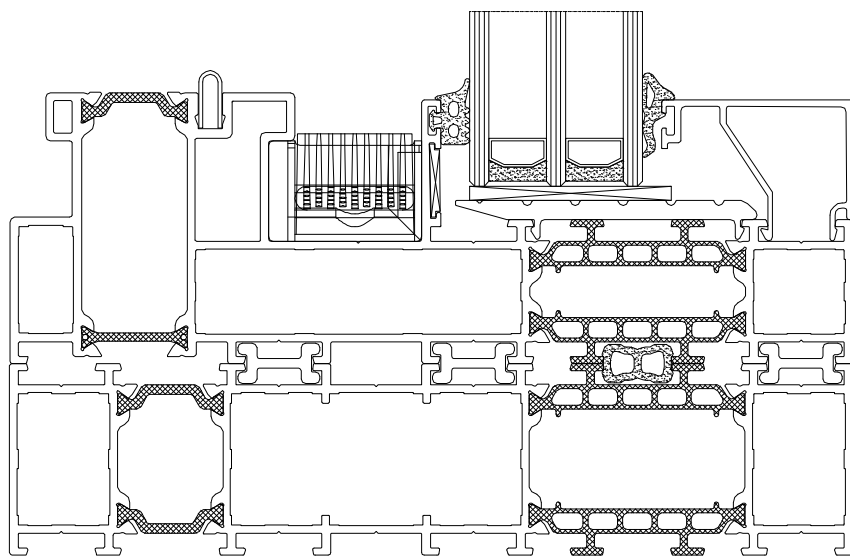
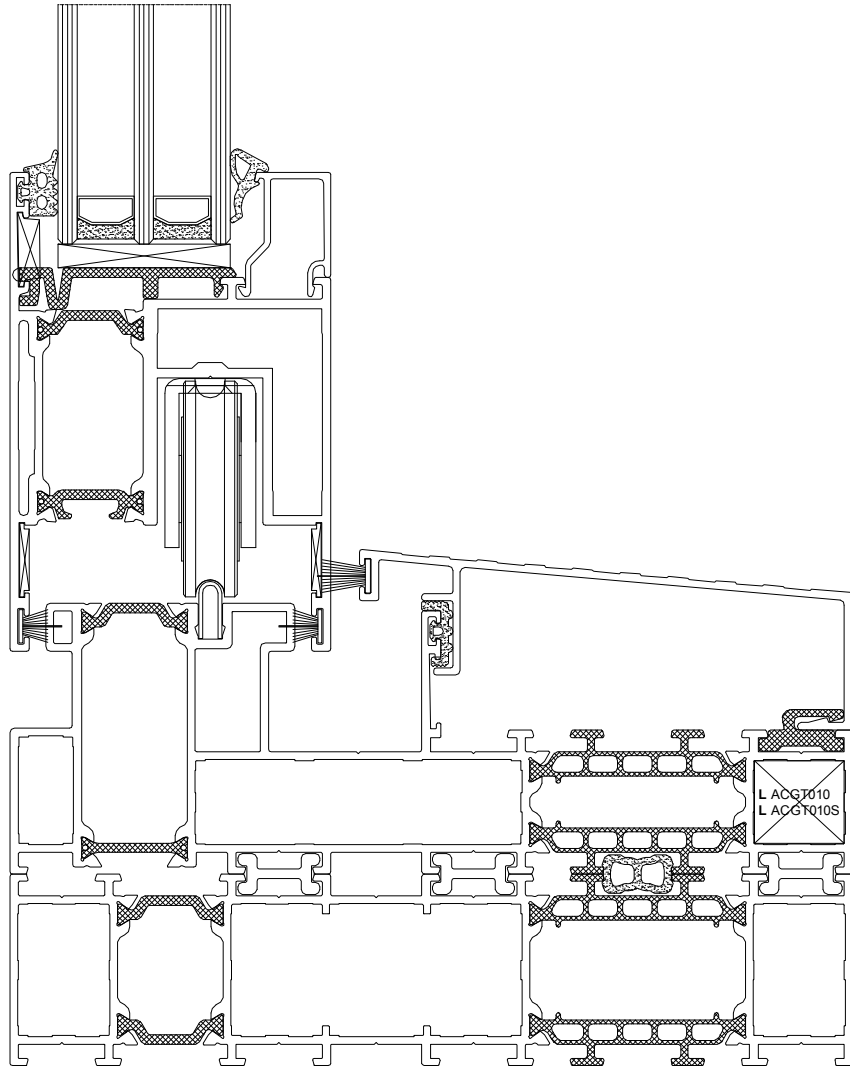

INSTALLATION GUIDELINES

installation\_14\_06\_2017\_en

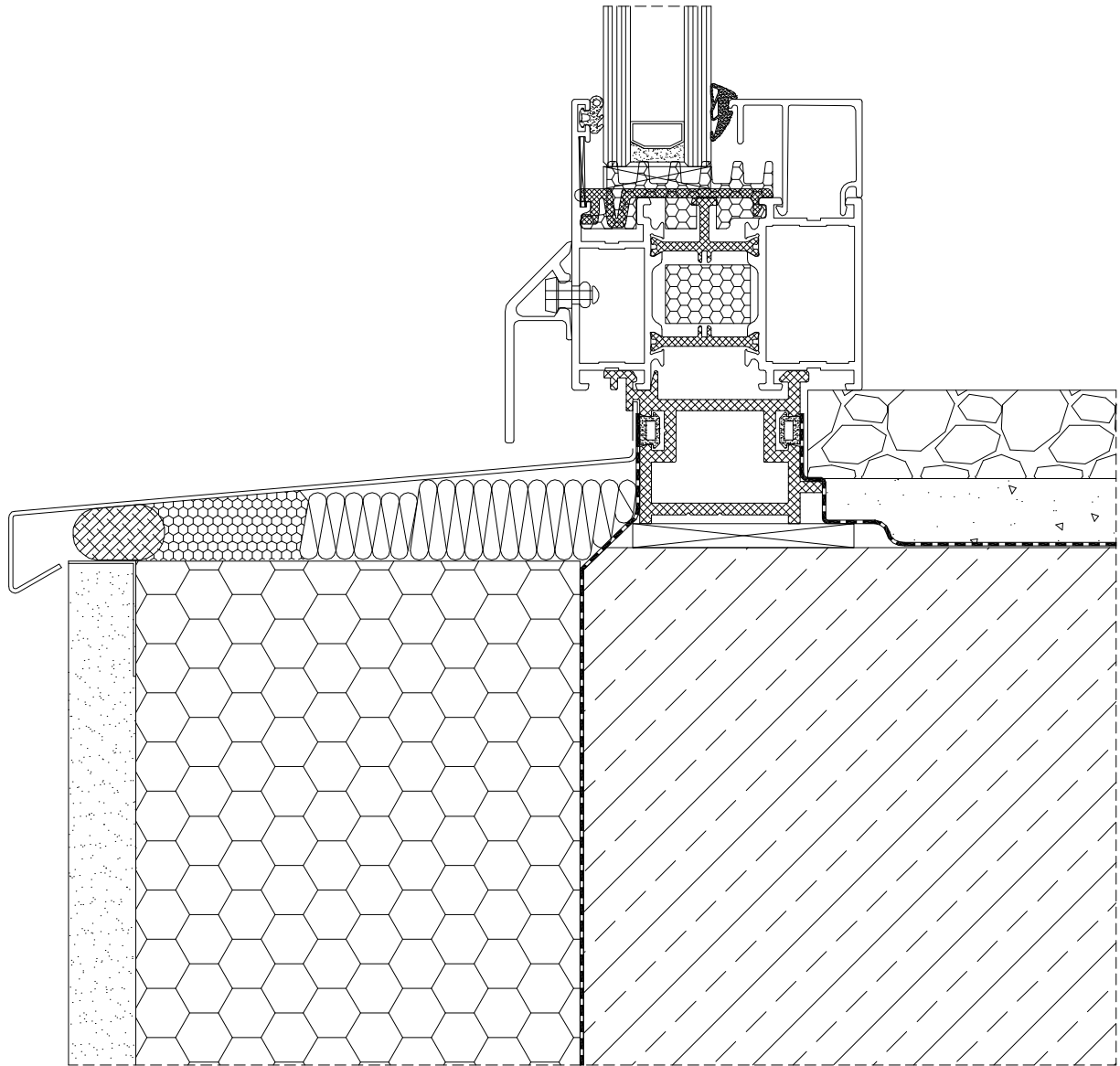

APPLICATION

APPLICATION

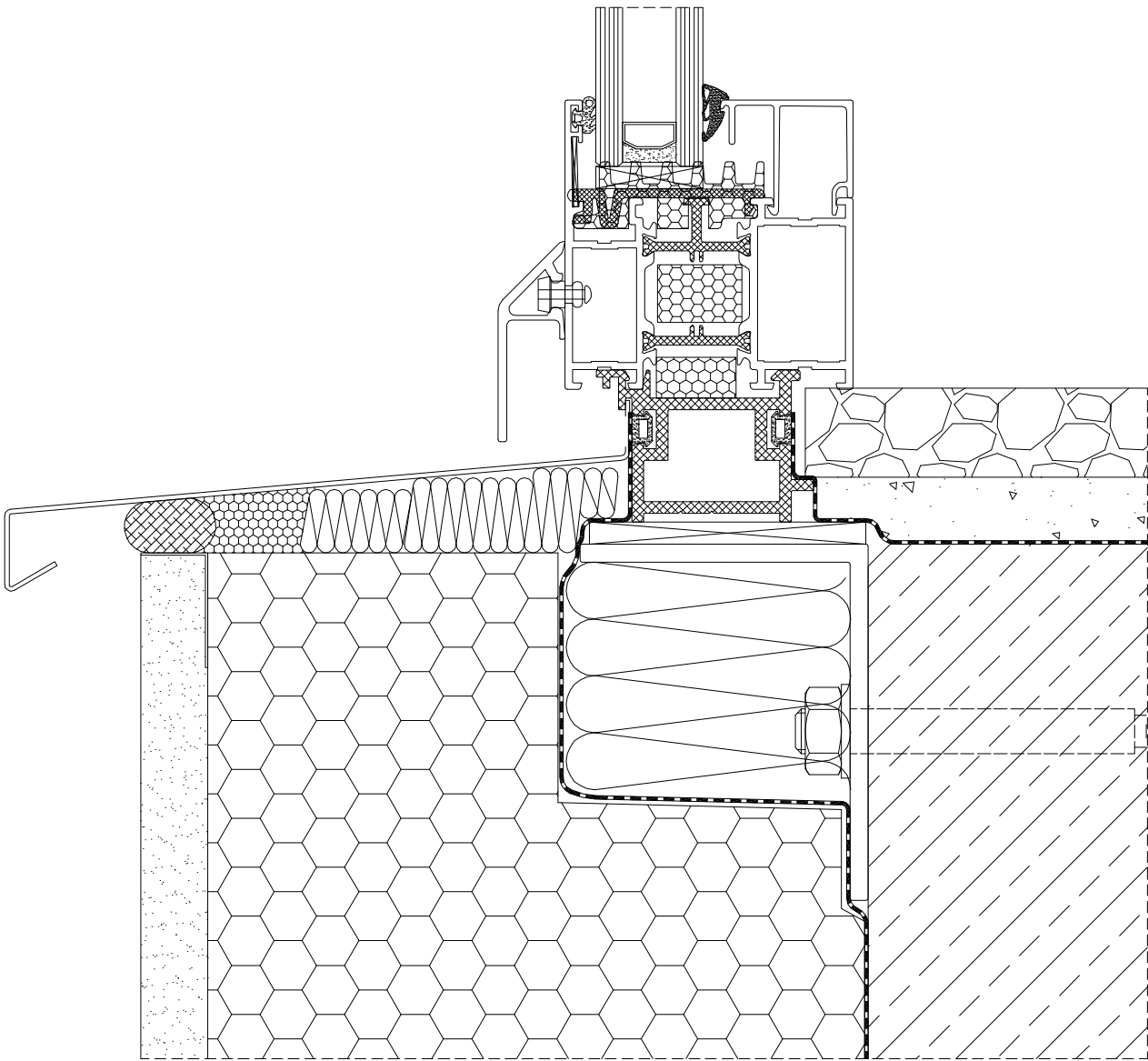

installation\_14\_06\_2017\_en

MO-C-002

16/6/2017

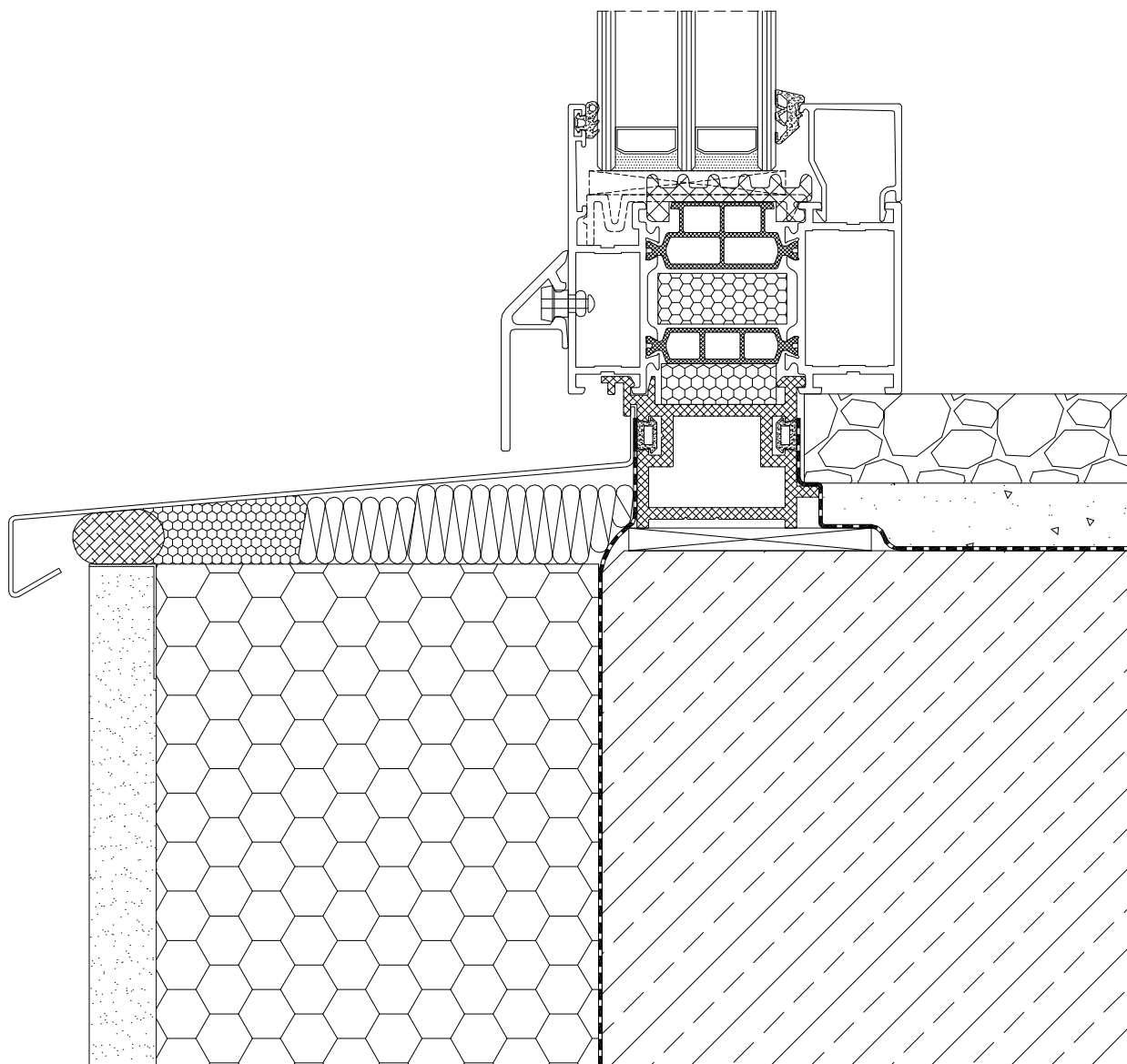

APPLICATION

APPLICATION

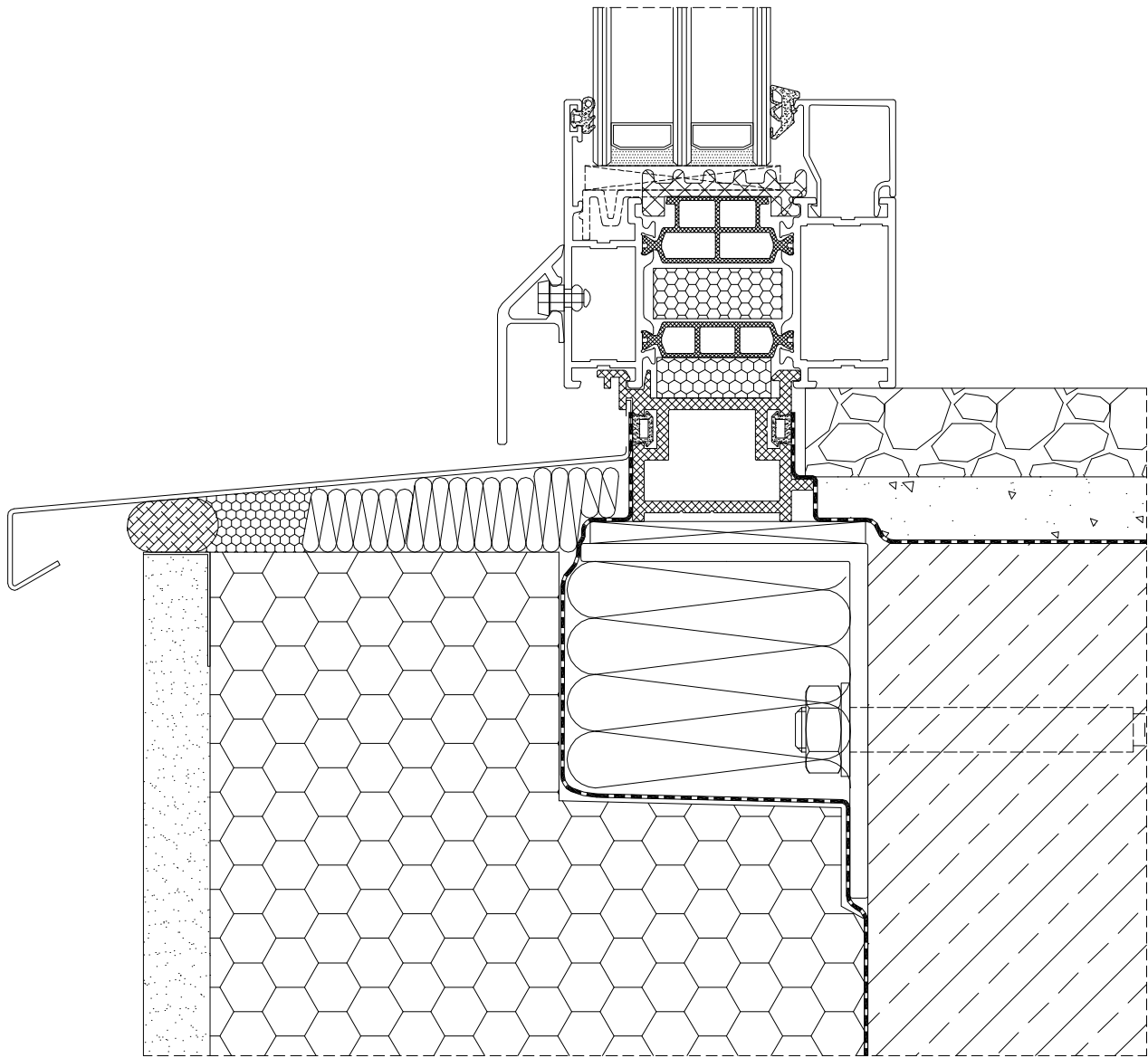

installation\_14\_06\_2017\_en

MO-C-004

16/6/2017

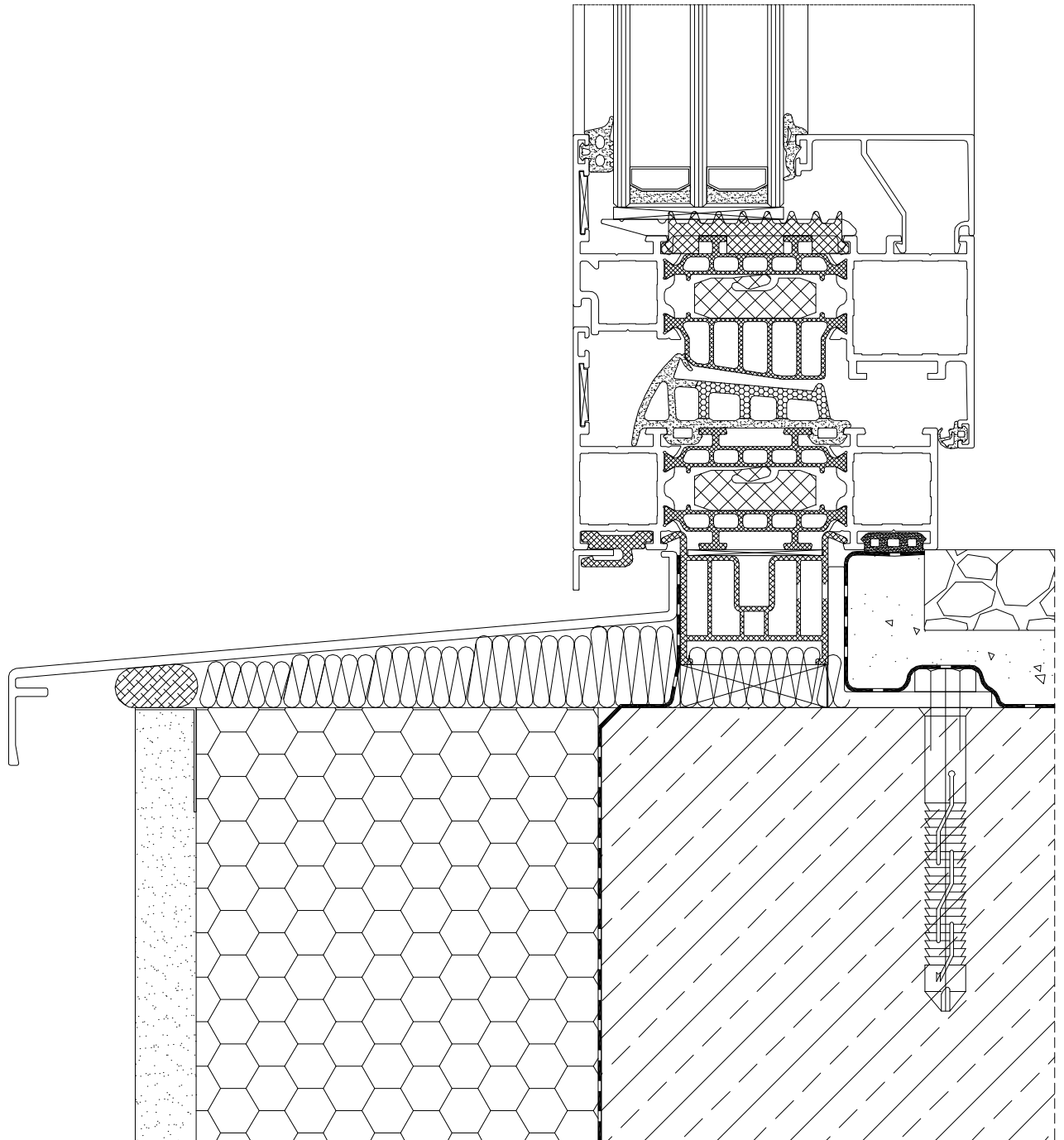

APPLICATION

installation\_14\_06\_2017\_en

APPLICATION

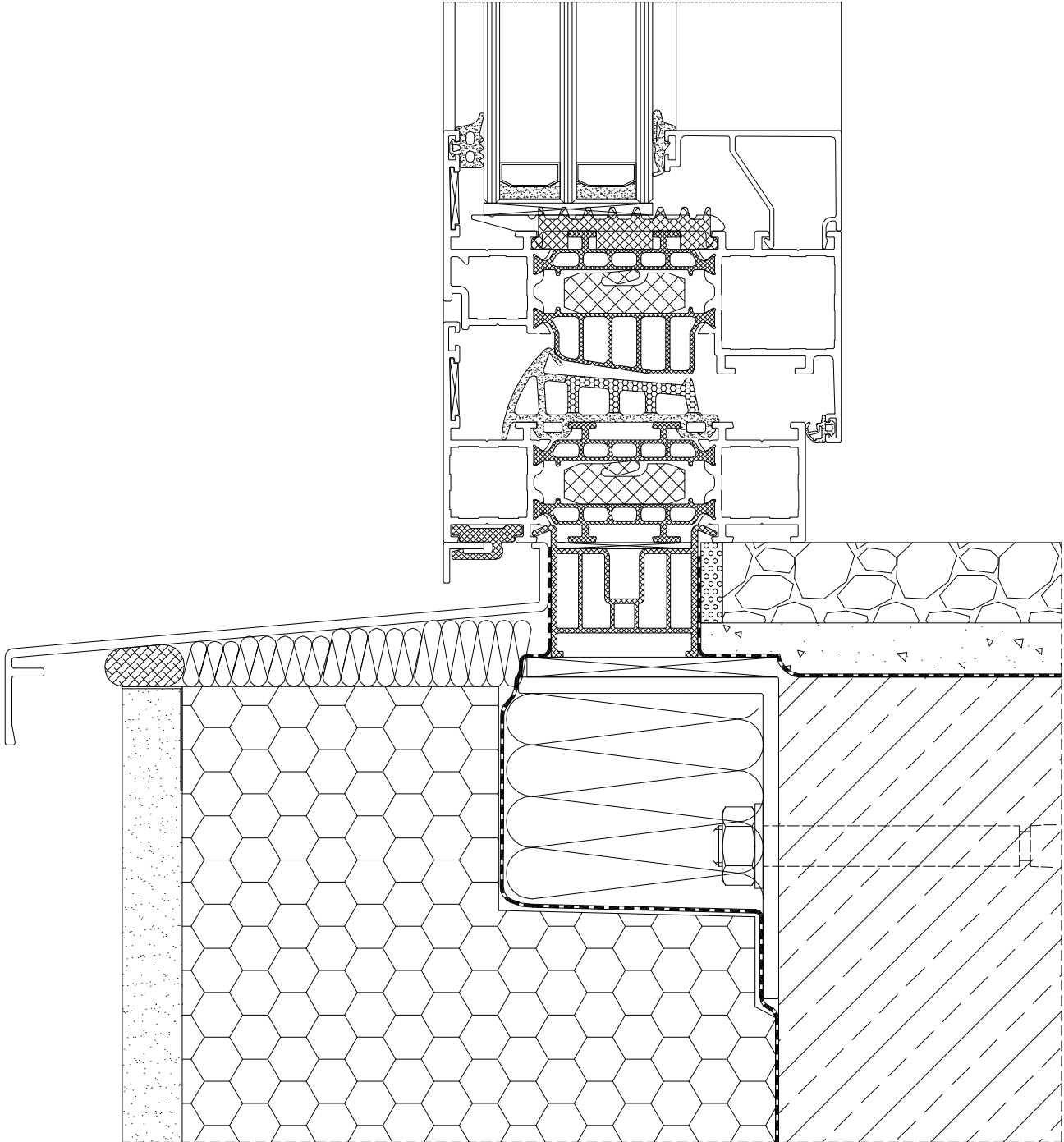

installation\_14\_06\_2017\_en

MO-C-006

16/6/2017



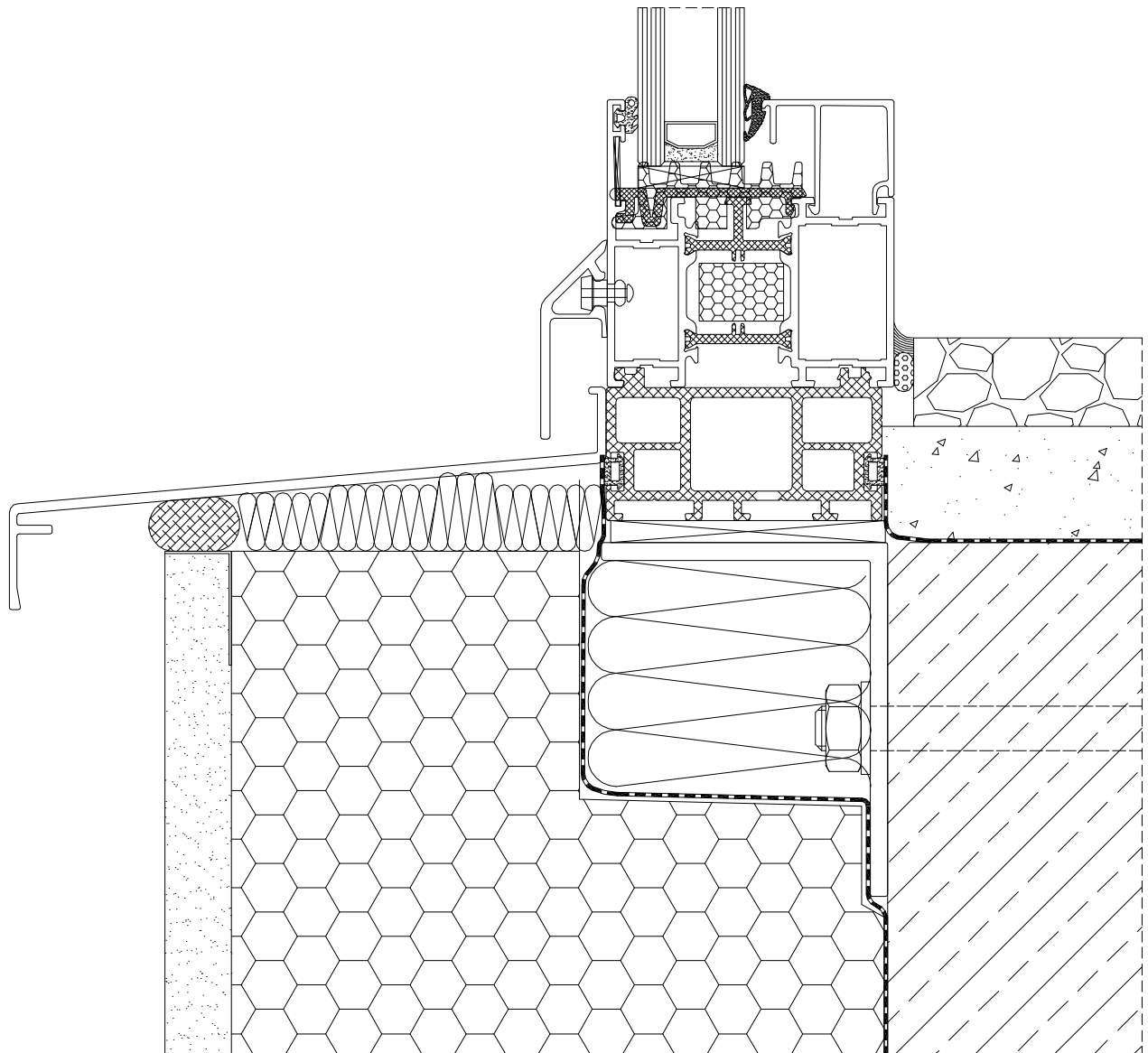

APPLICATION

APPLICATION

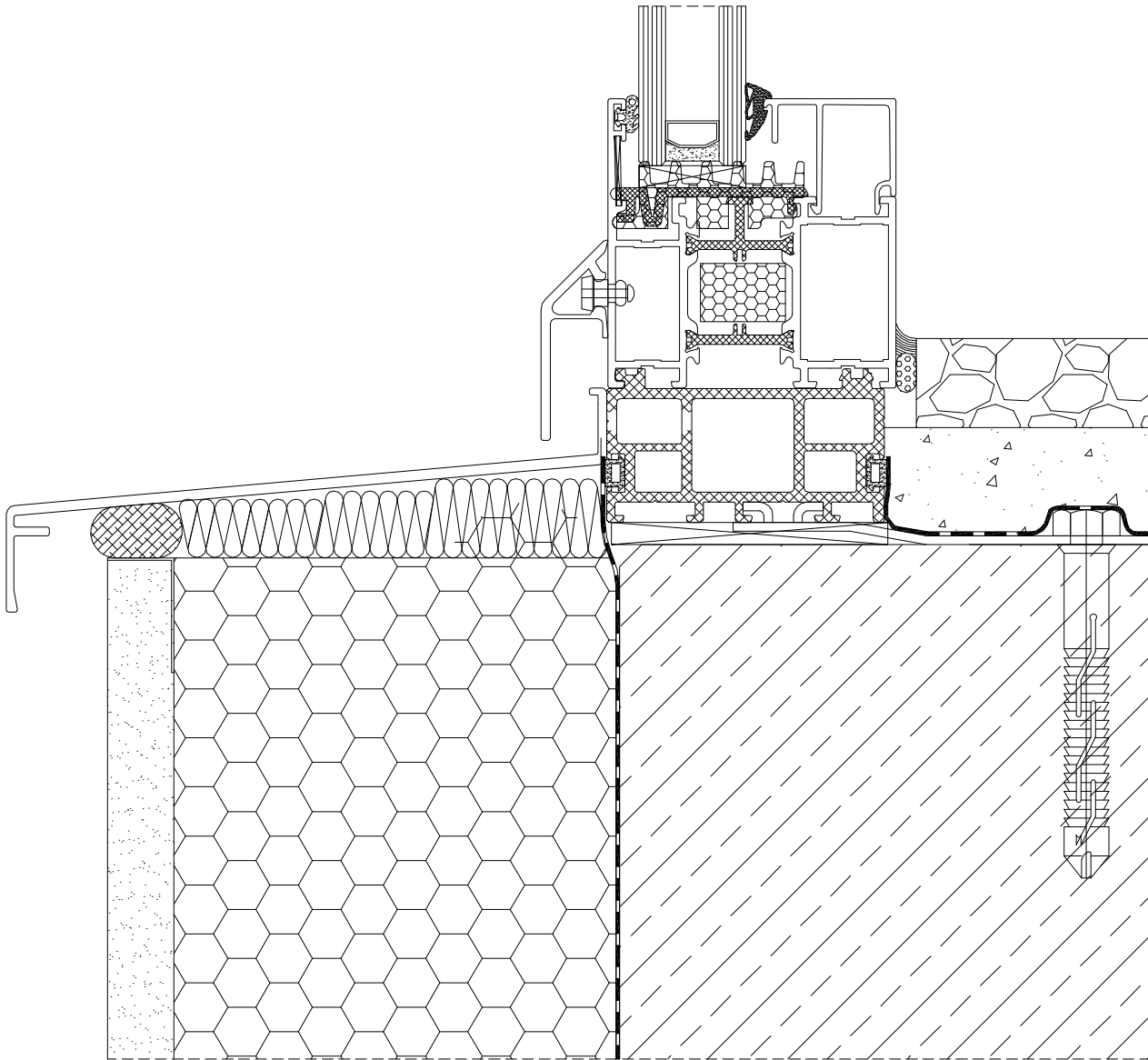

installation\_14\_06\_2017\_en

MO-C-008

16/6/2017

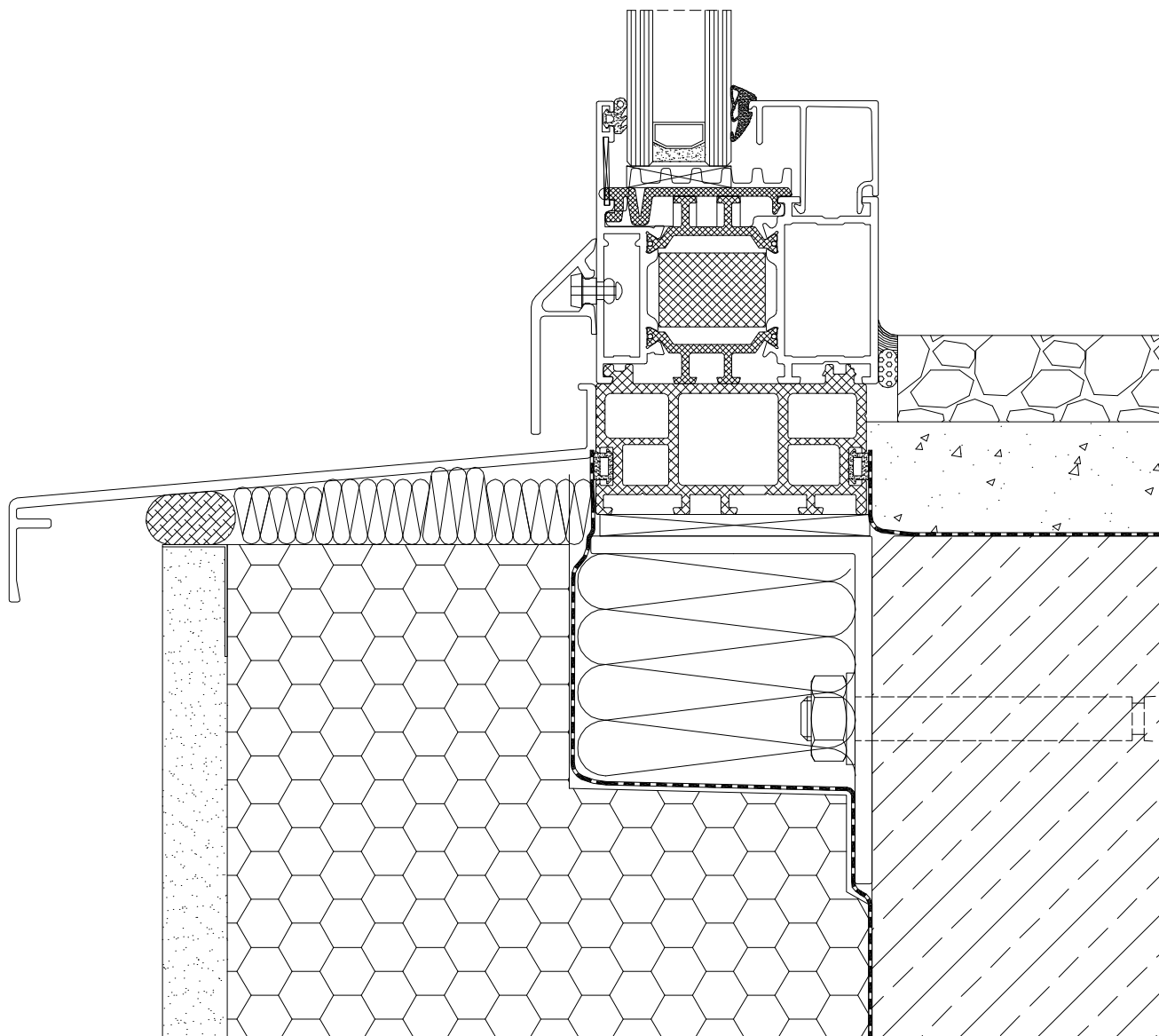

APPLICATION

APPLICATION

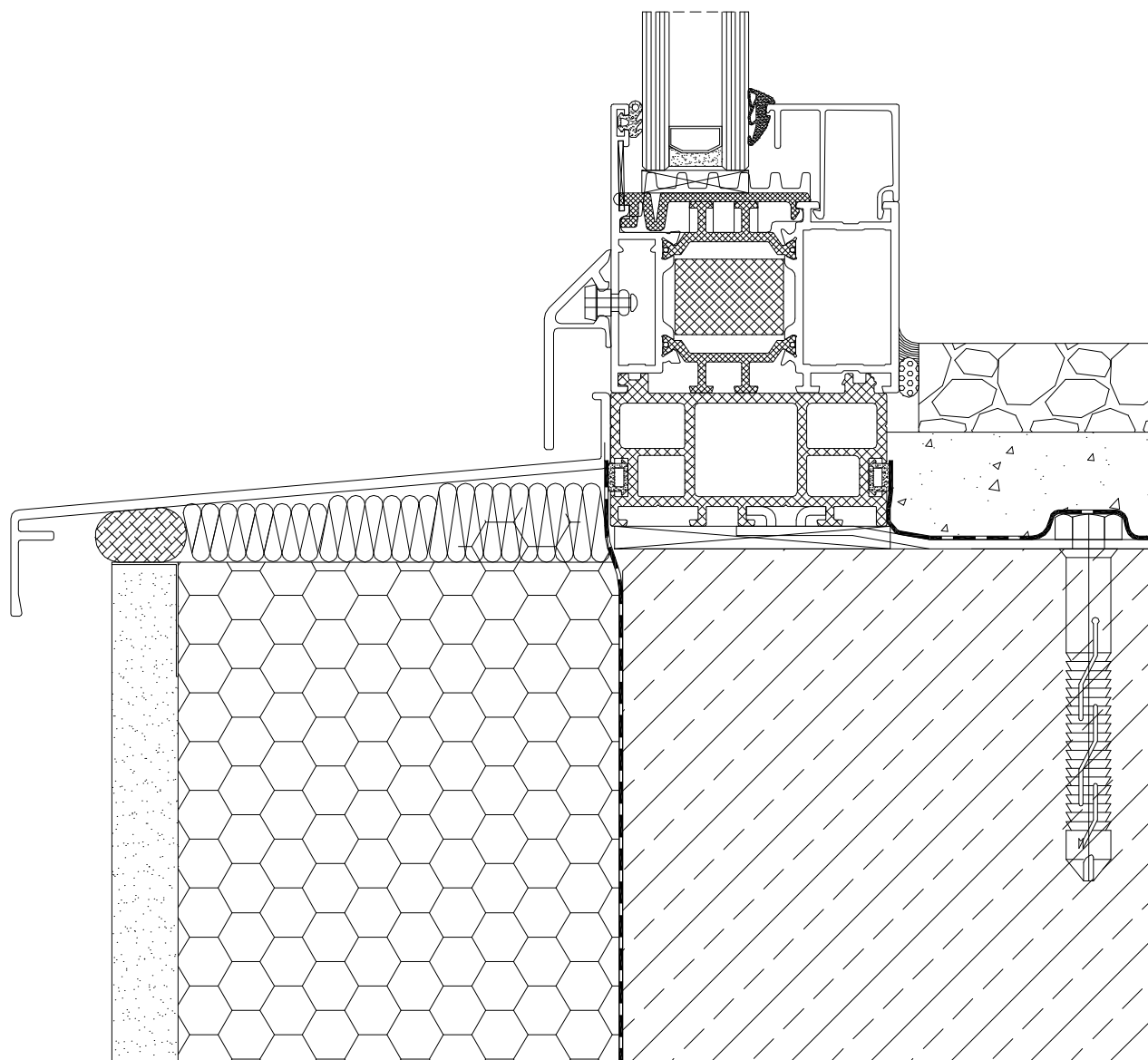

installation\_14\_06\_2017\_en

MO-C-010

16/6/2017

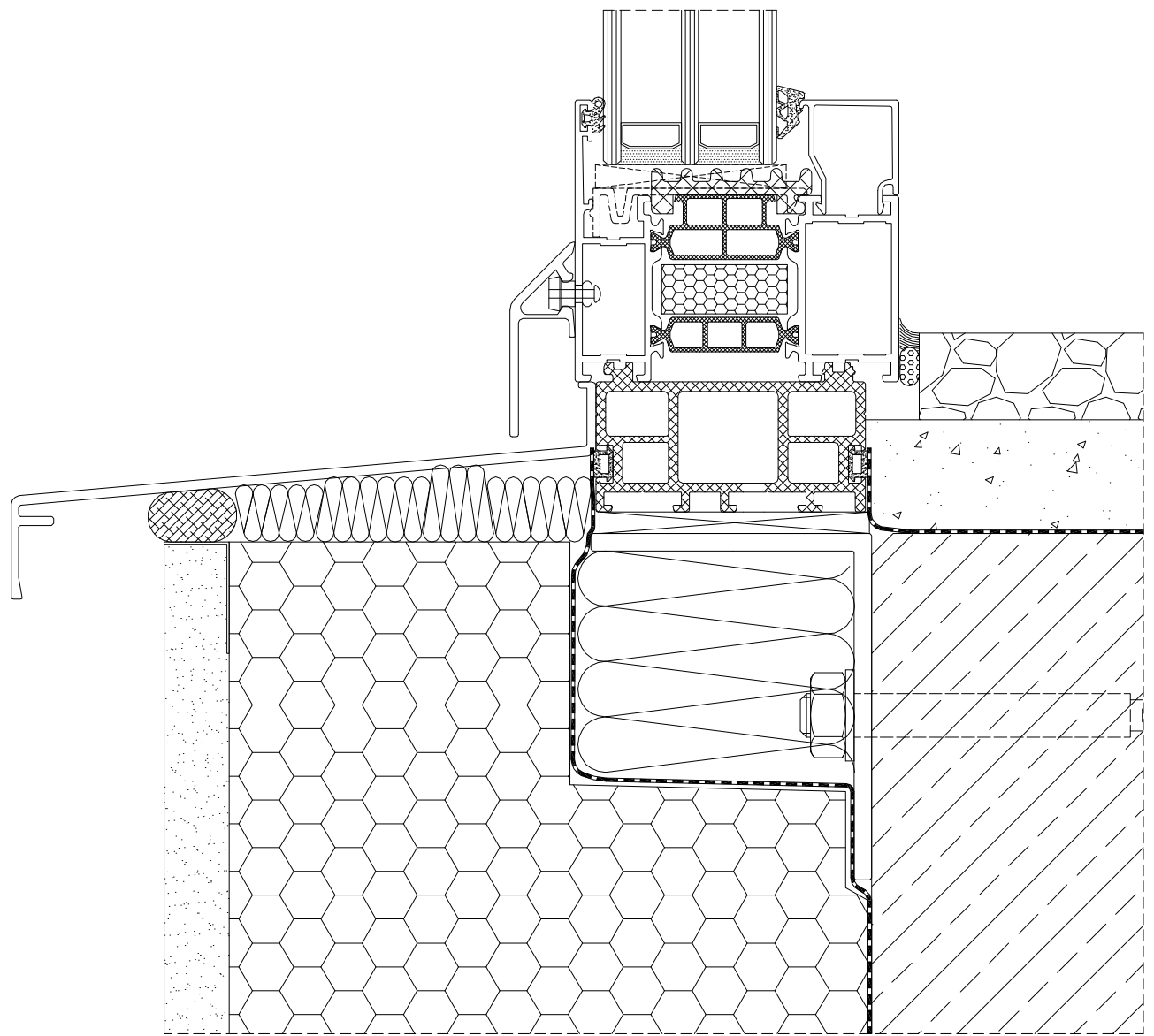

APPLICATION

APPLICATION

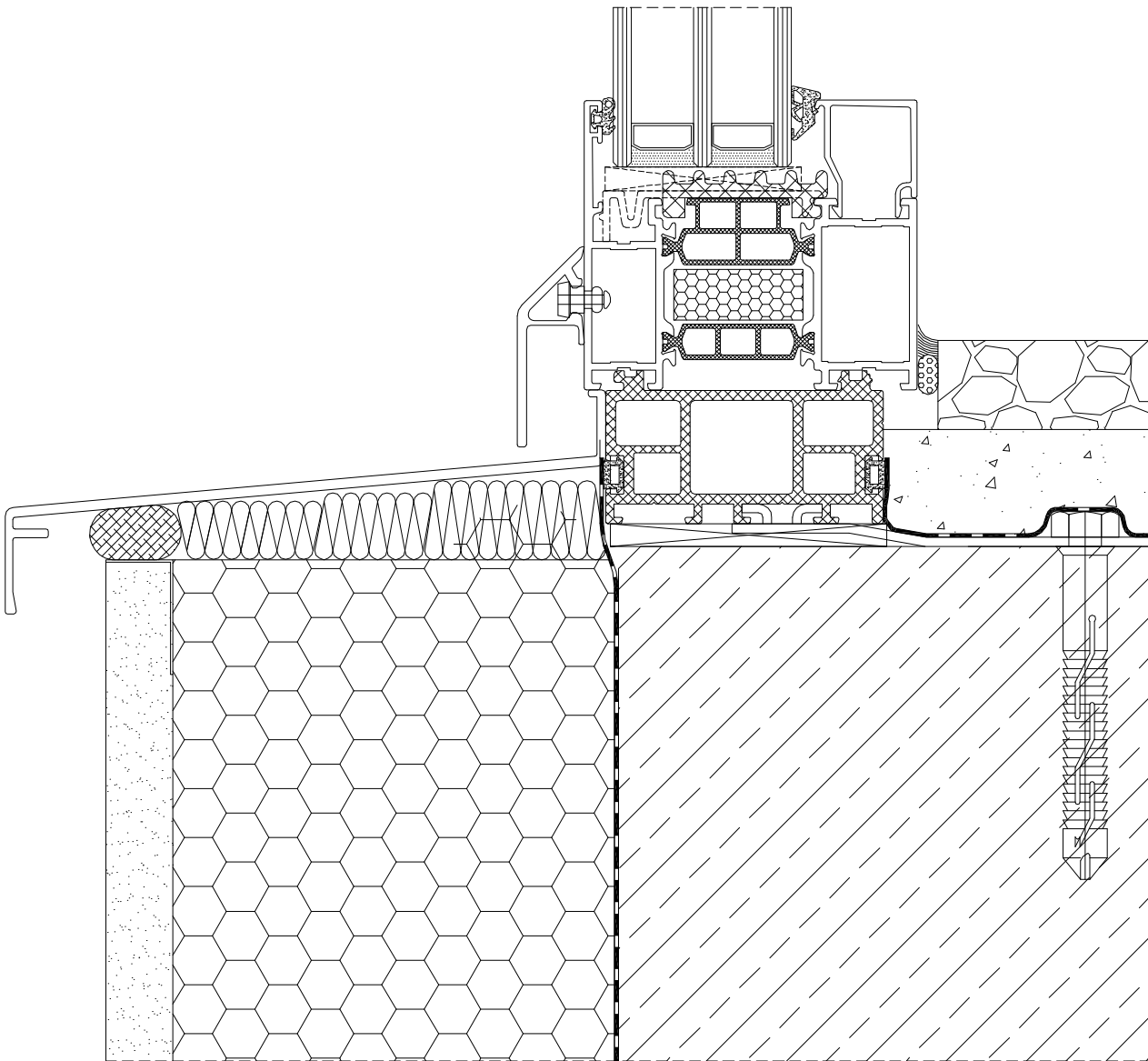

installation\_14\_06\_2017\_en

MO-C-012

16/6/2017

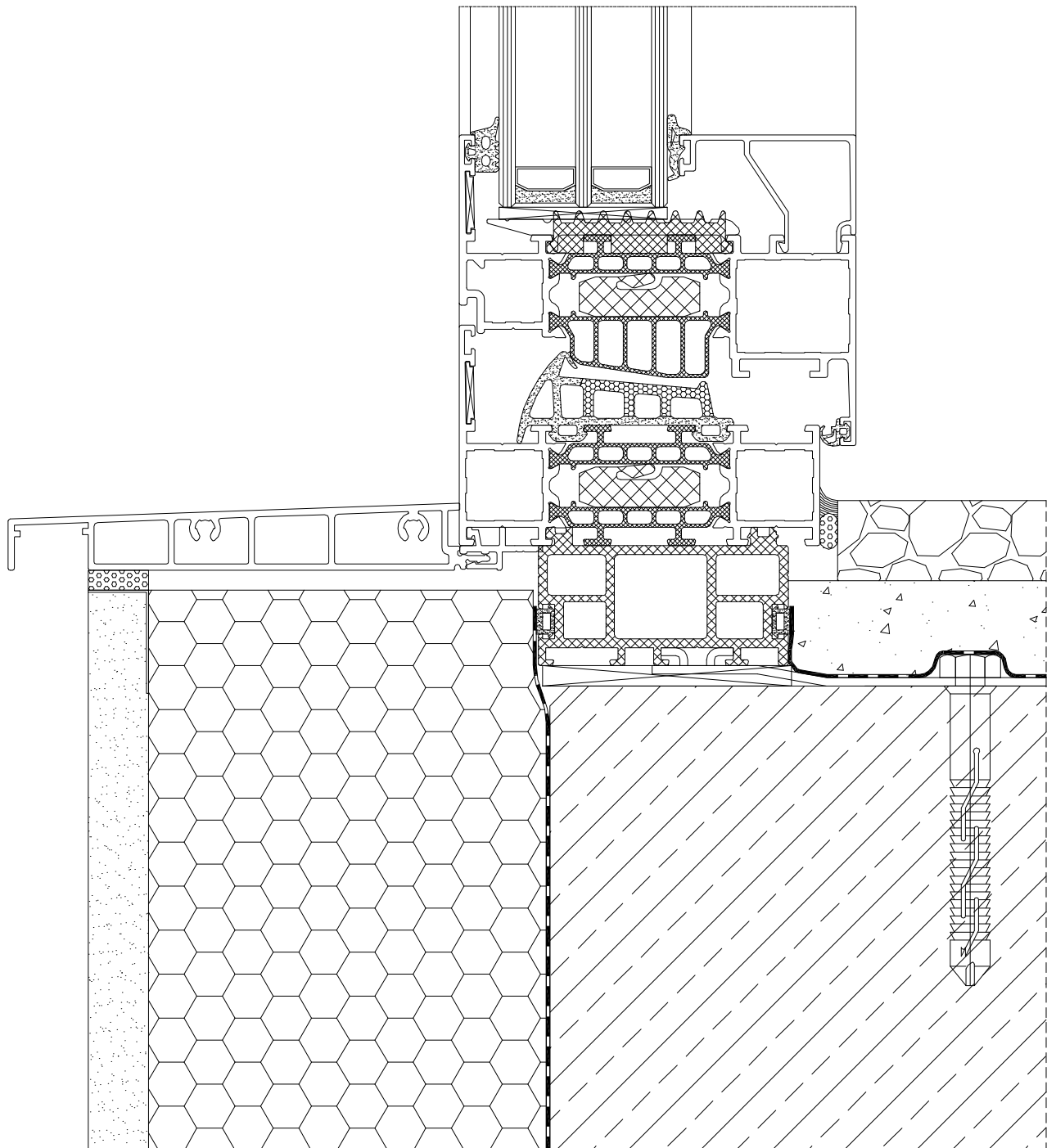

APPLICATION

installation\_14\_06\_2017\_en

APPLICATION

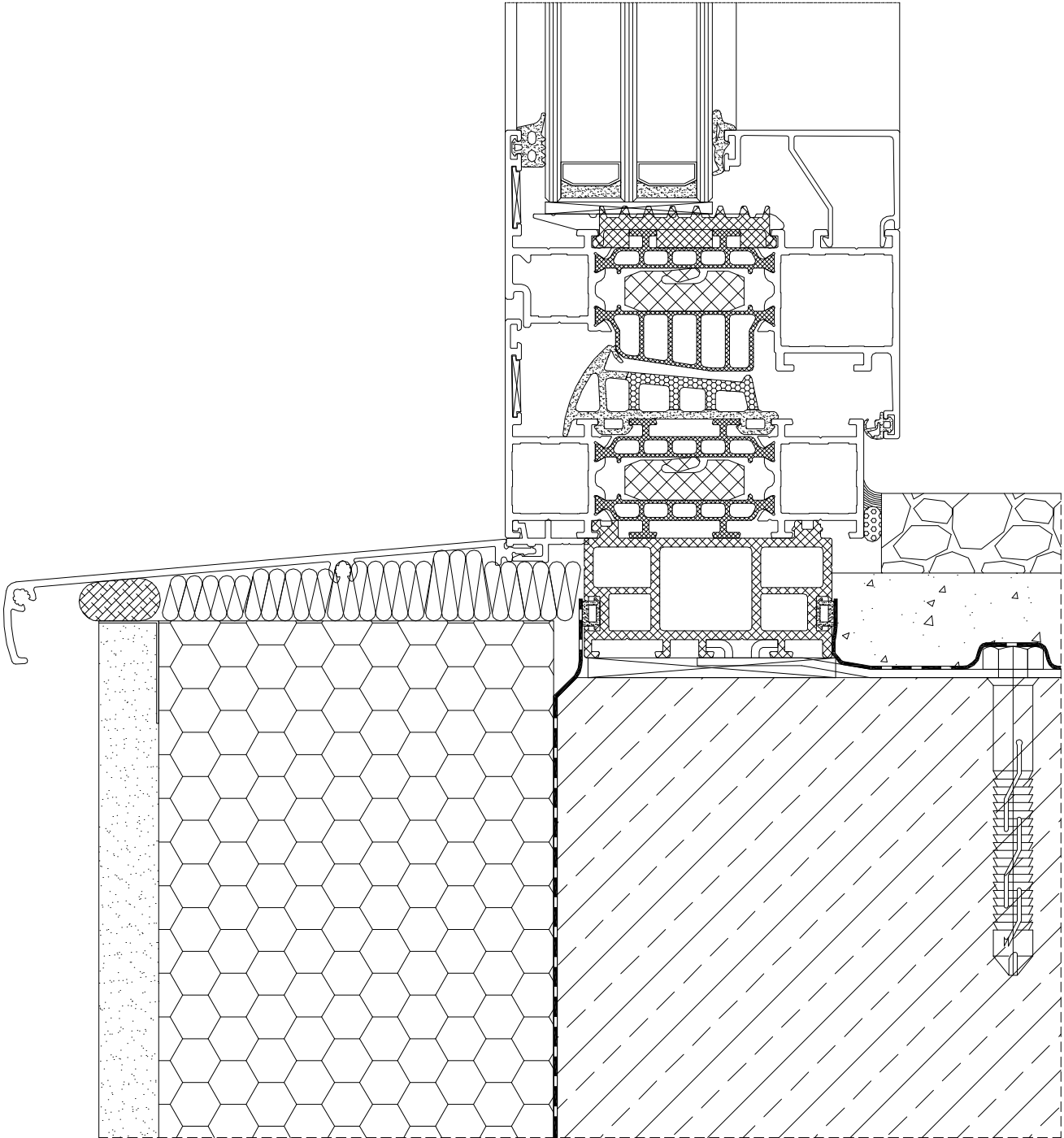

installation\_14\_06\_2017\_en

MO-C-014

16/6/2017



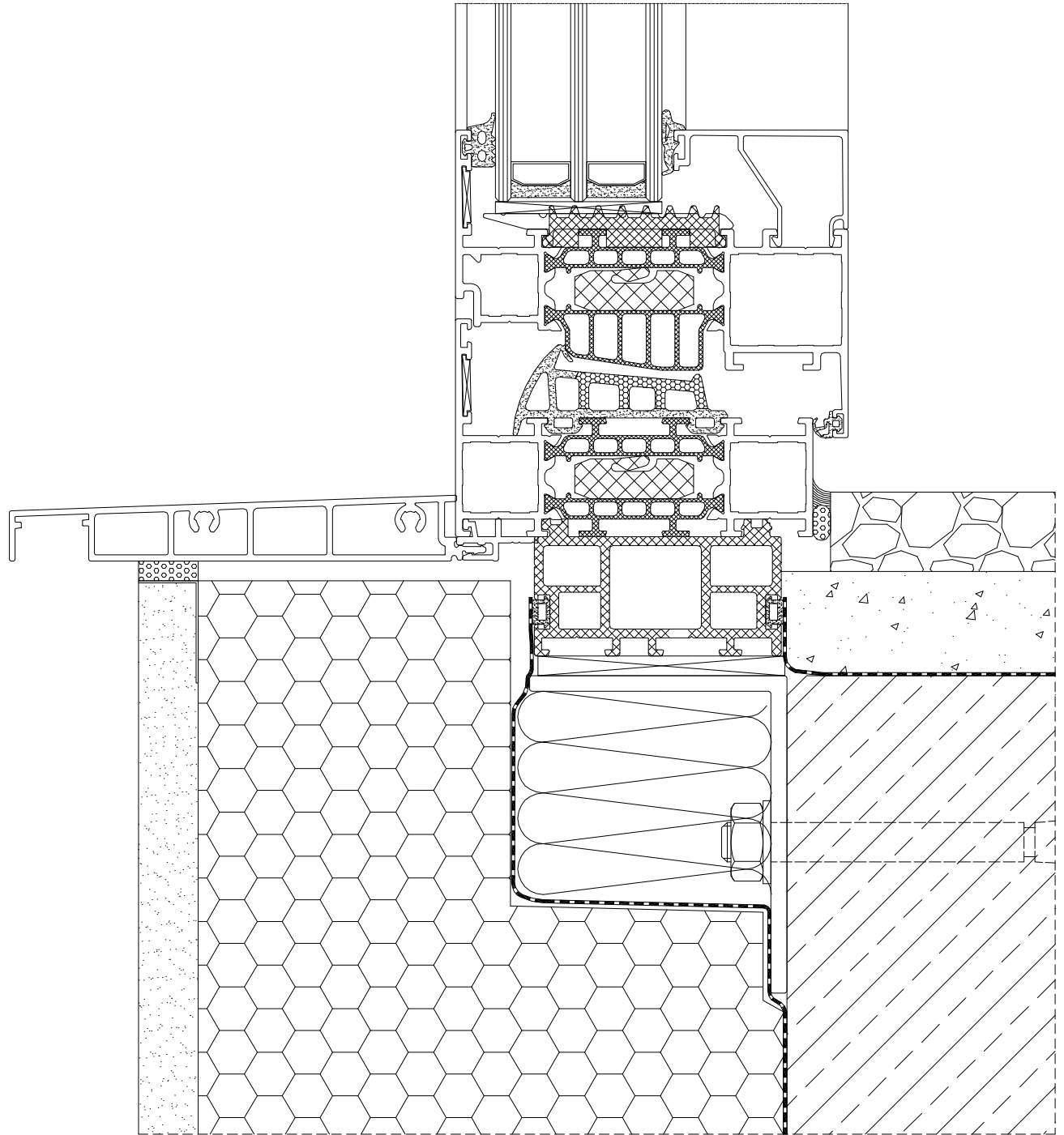

APPLICATION

installation\_14\_06\_2017\_en

APPLICATION

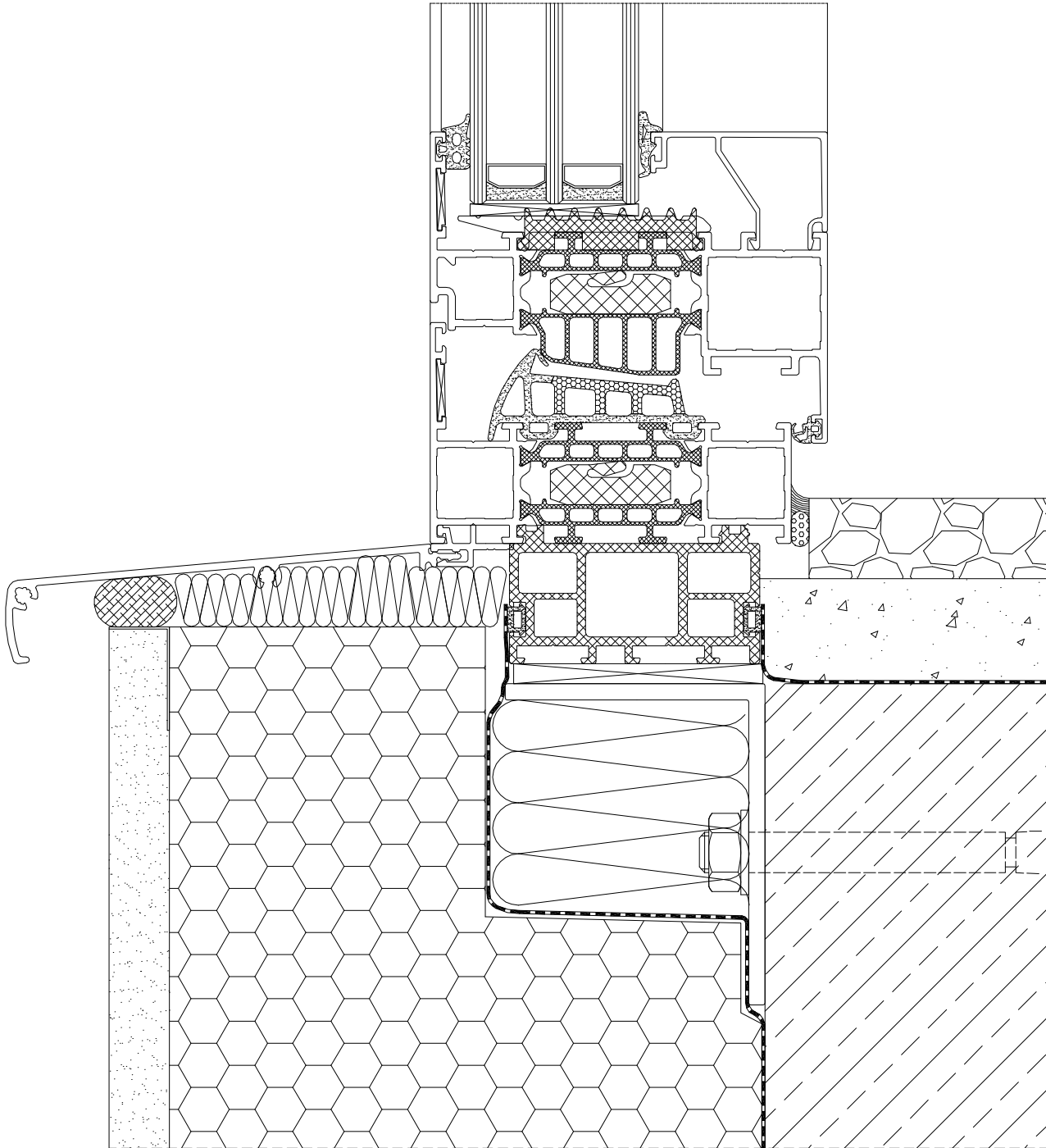

installation\_14\_06\_2017\_en

MO-C-016

16/6/2017

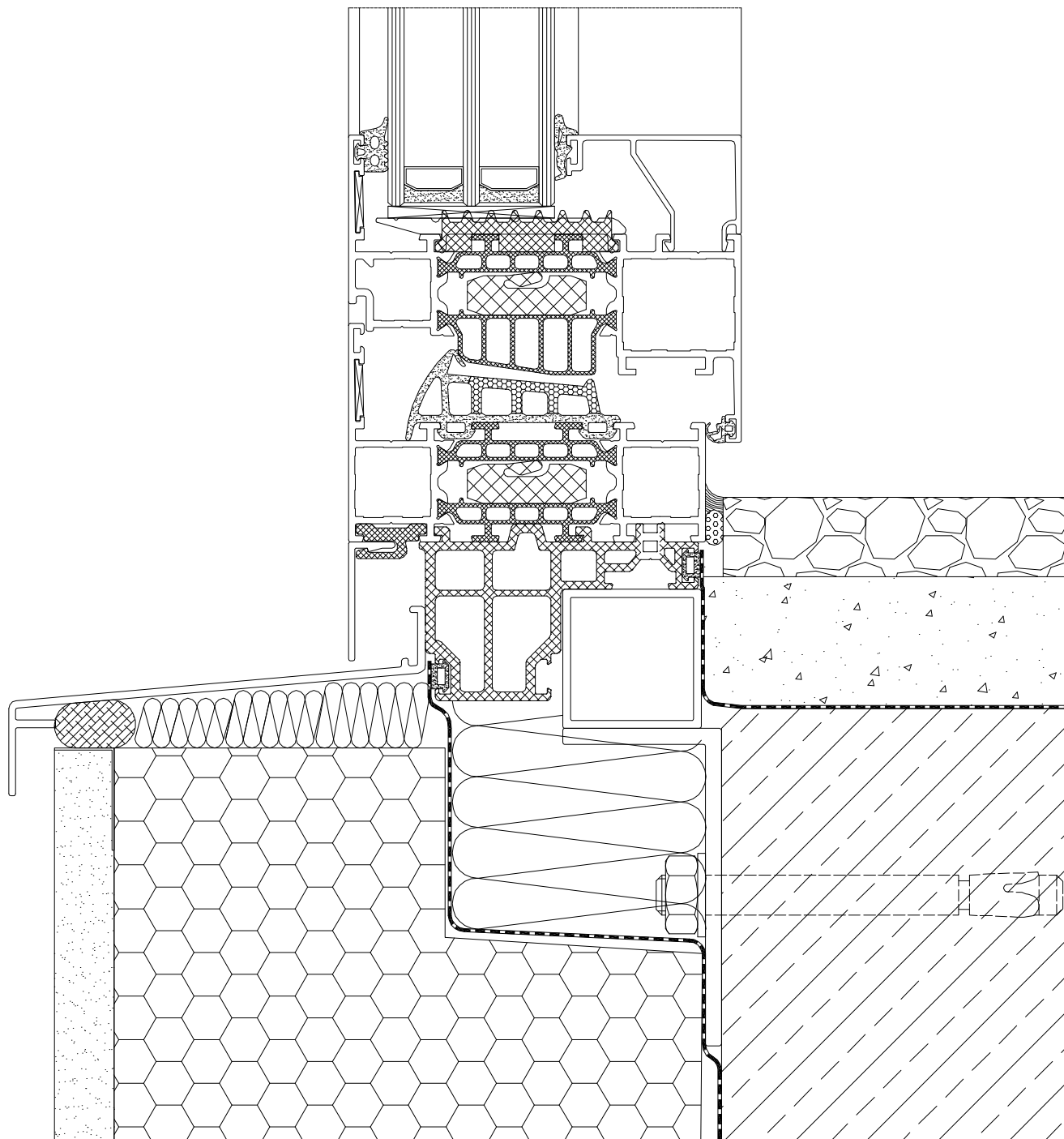

APPLICATION

installation\_14\_06\_2017\_en

APPLICATION

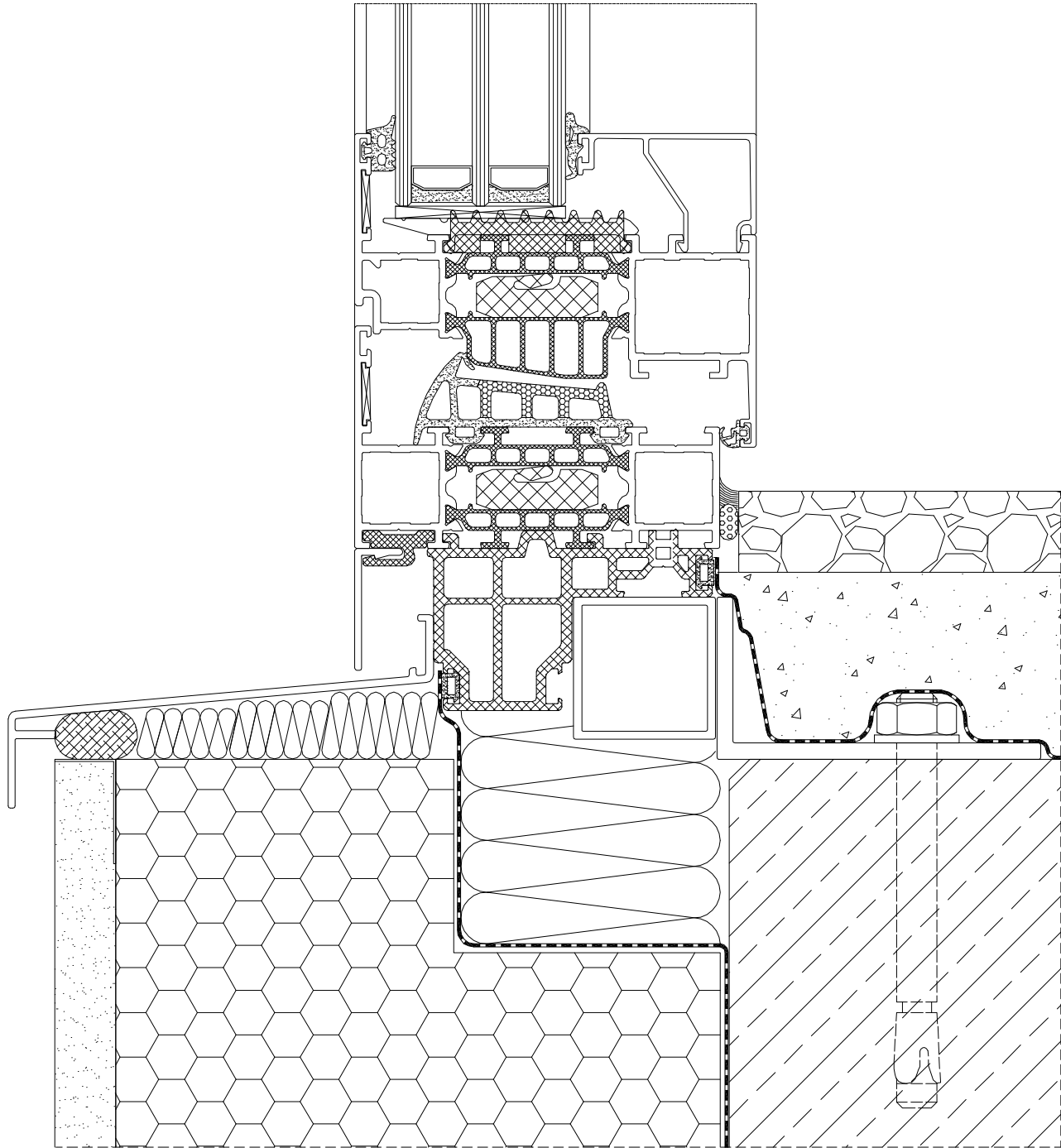

installation\_14\_06\_2017\_en

MO-C-018

16/6/2017

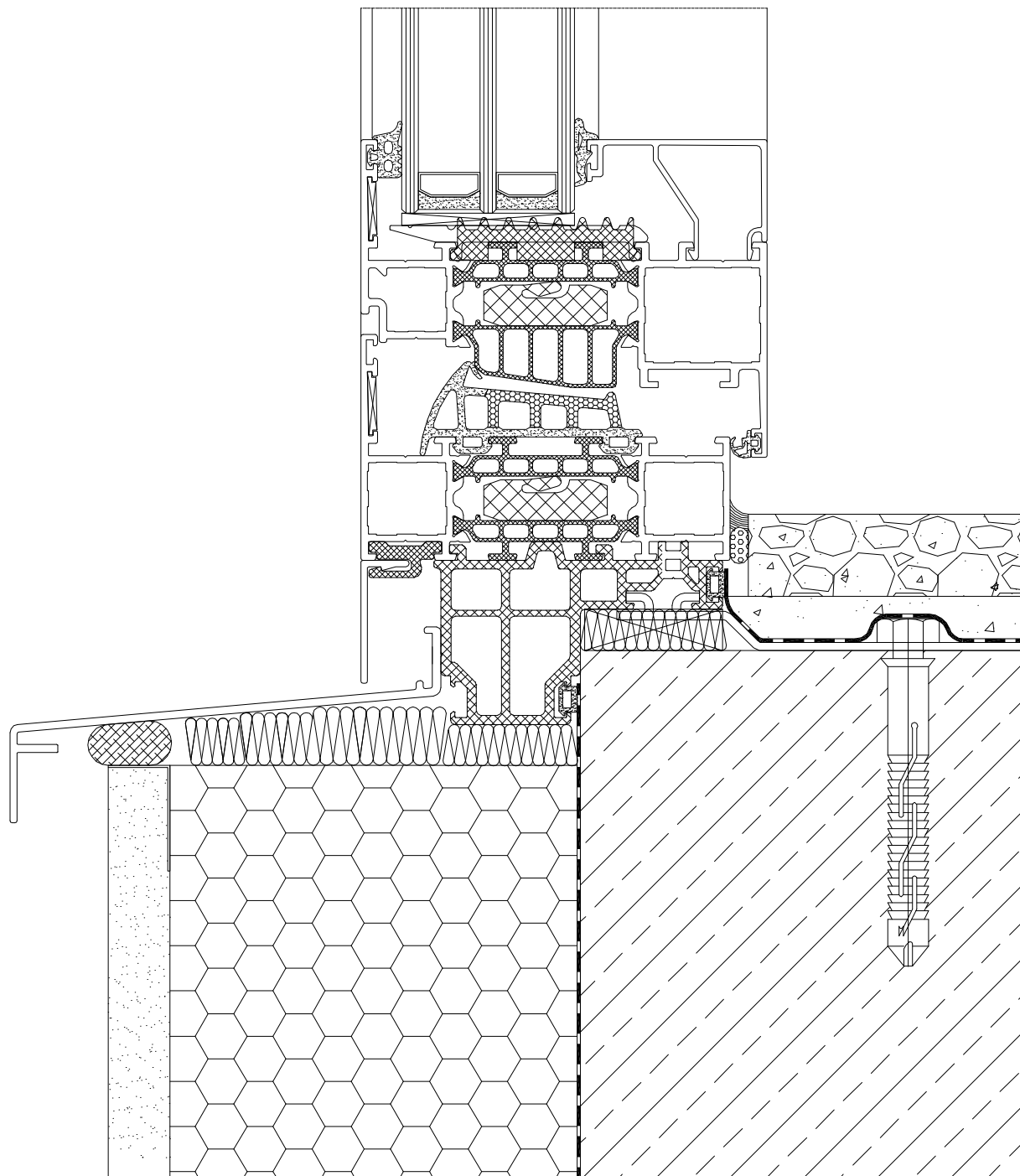

APPLICATION

installation\_14\_06\_2017\_en

APPLICATION

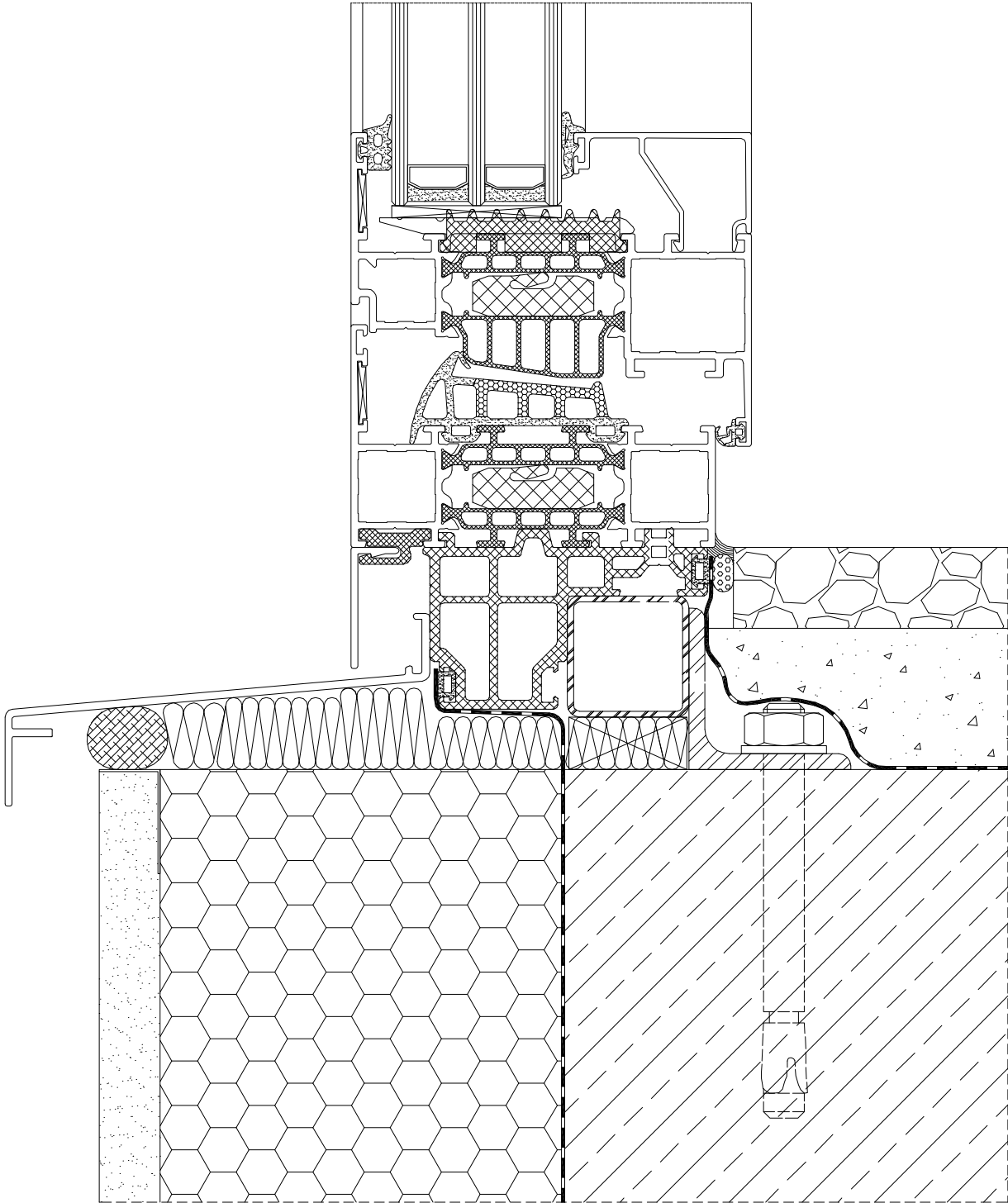

installation\_14\_06\_2017\_en

MO-C-020

16/6/2017

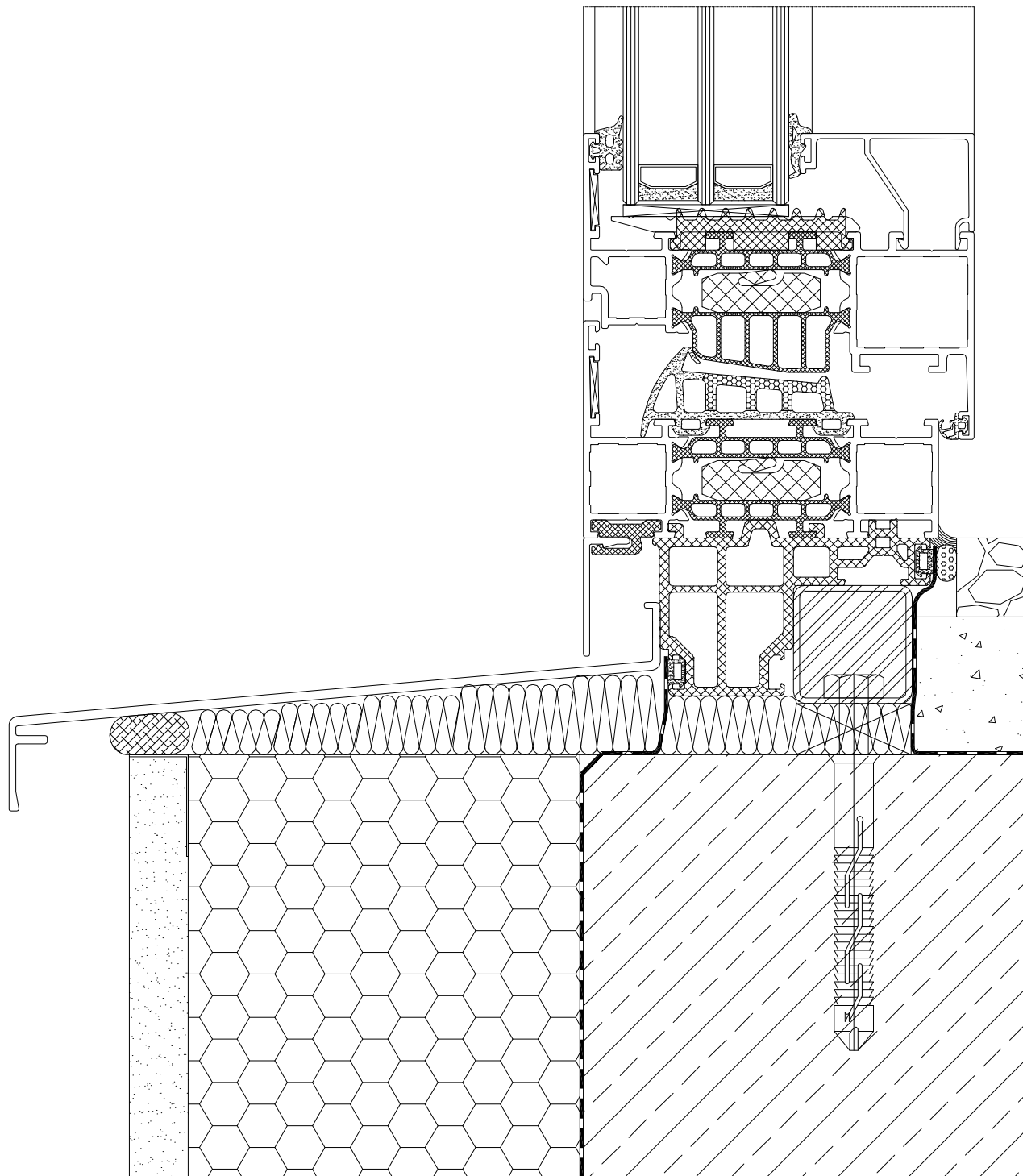

APPLICATION

installation\_14\_06\_2017\_en

APPLICATION

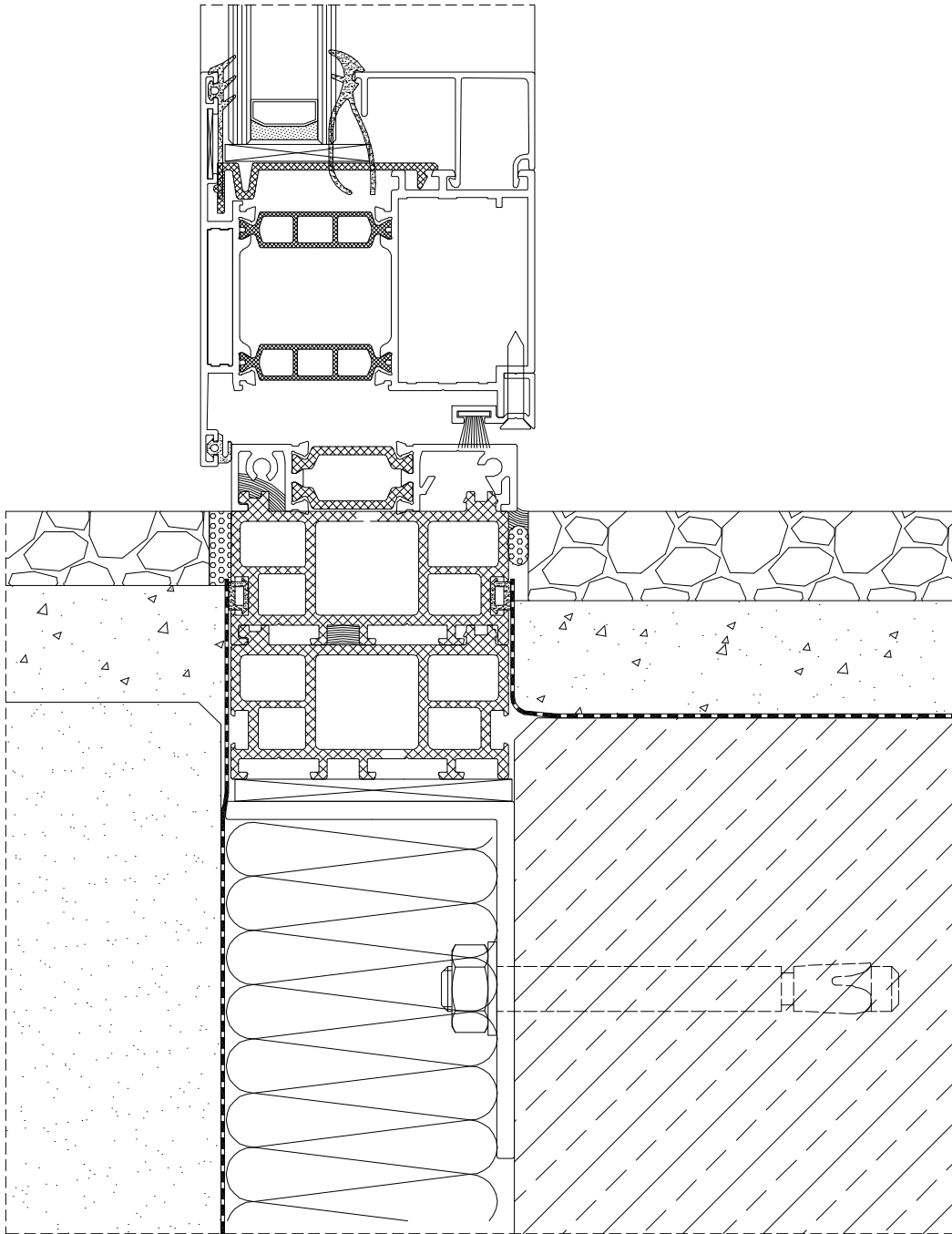

installation\_14\_06\_2017\_en

MO-C-022

16/6/2017



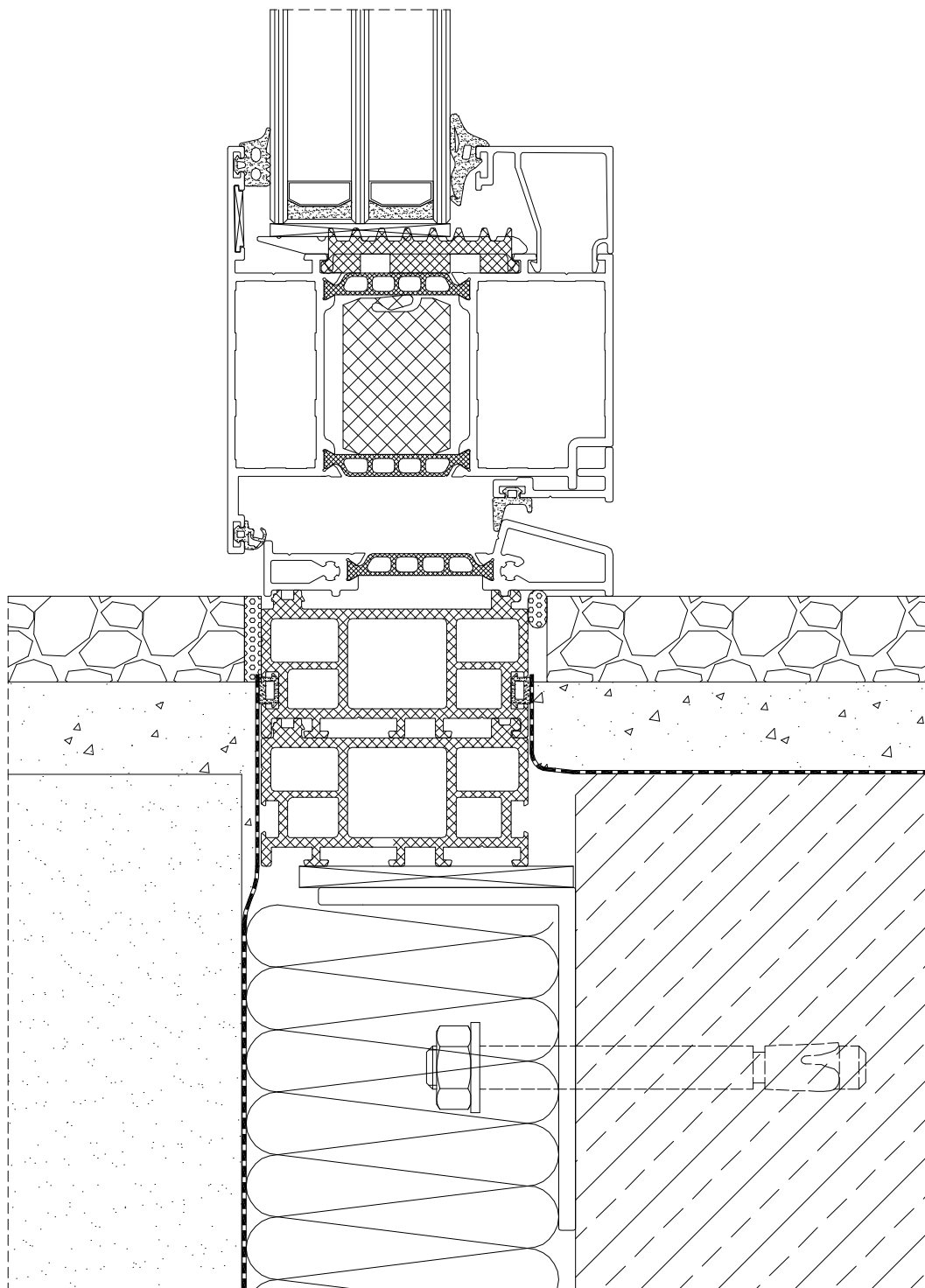

APPLICATION

installation\_14\_06\_2017\_en

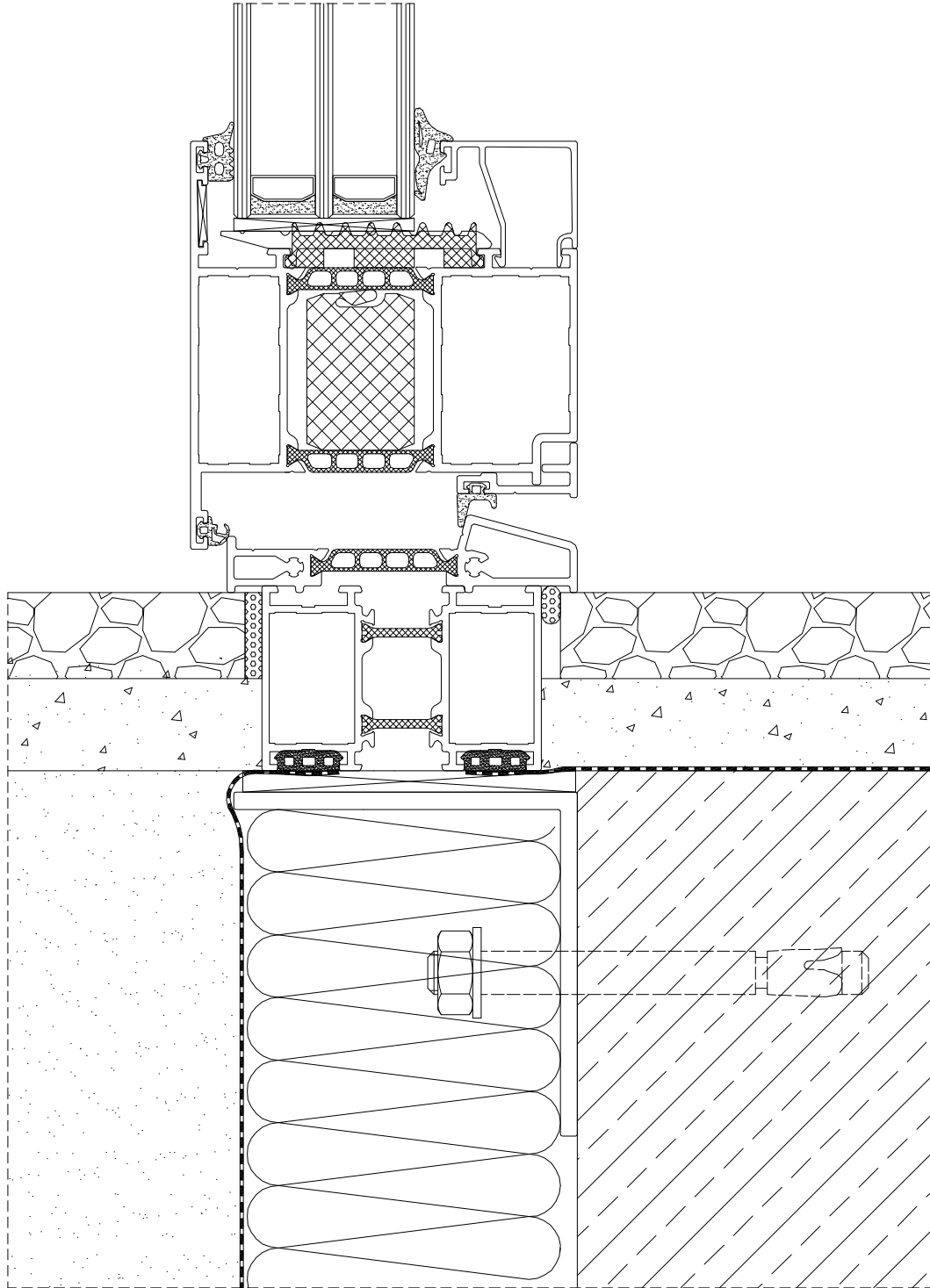

APPLICATION

installation\_14\_06\_2017\_en

MO-C-024

16/6/2017

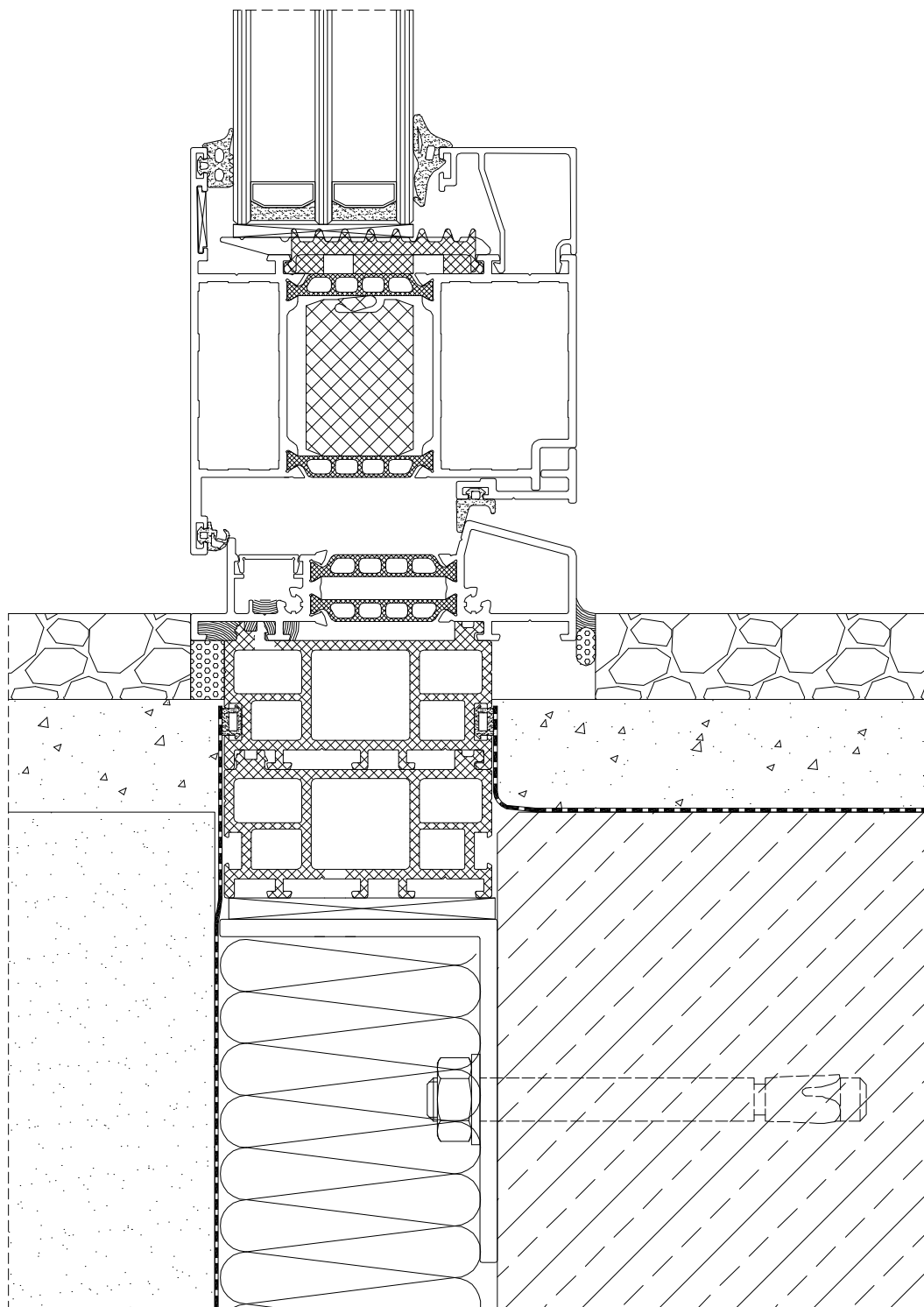

APPLICATION

installation\_14\_06\_2017\_en

APPLICATION

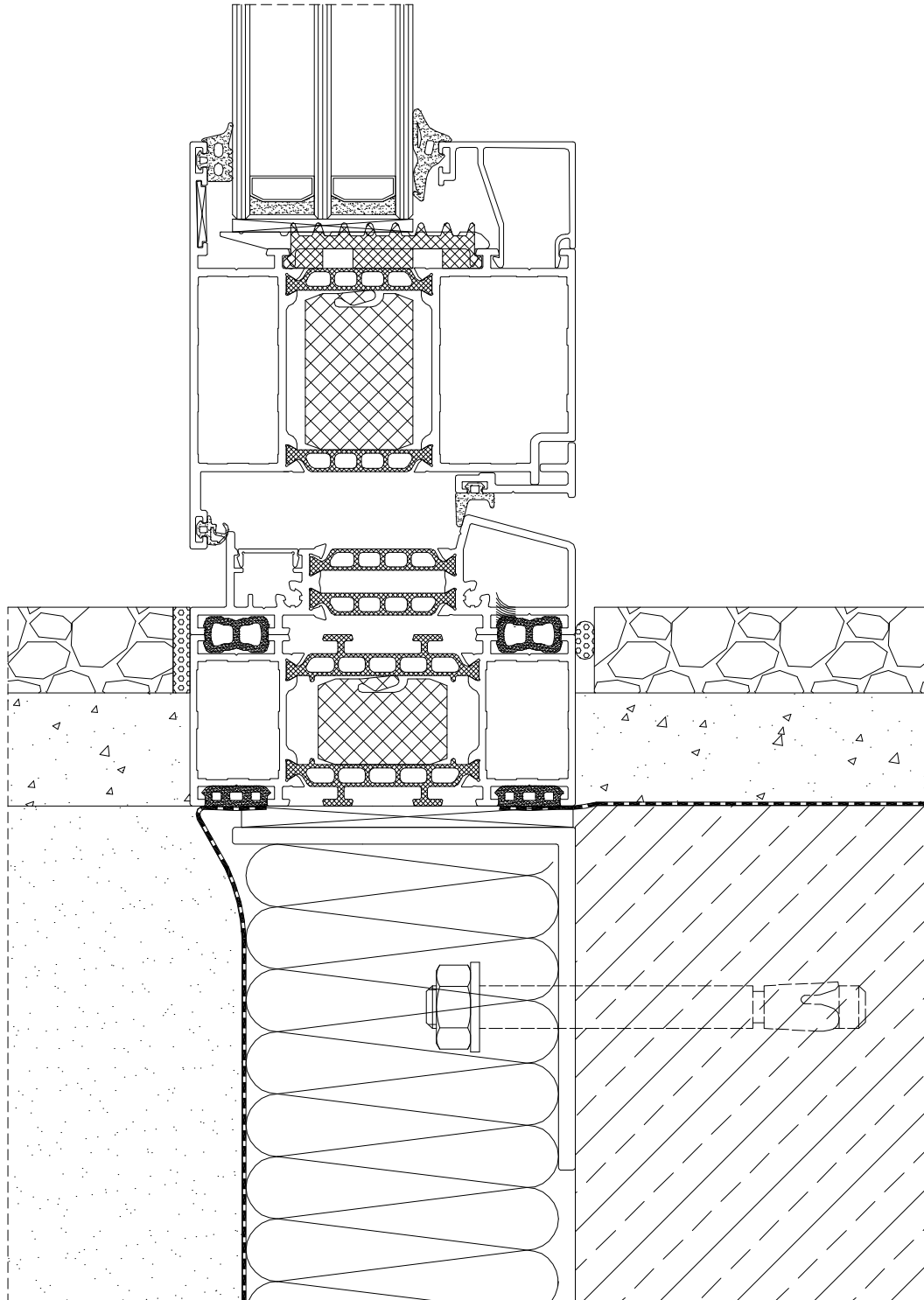

installation\_14\_06\_2017\_en

MO-C-026

16/6/2017

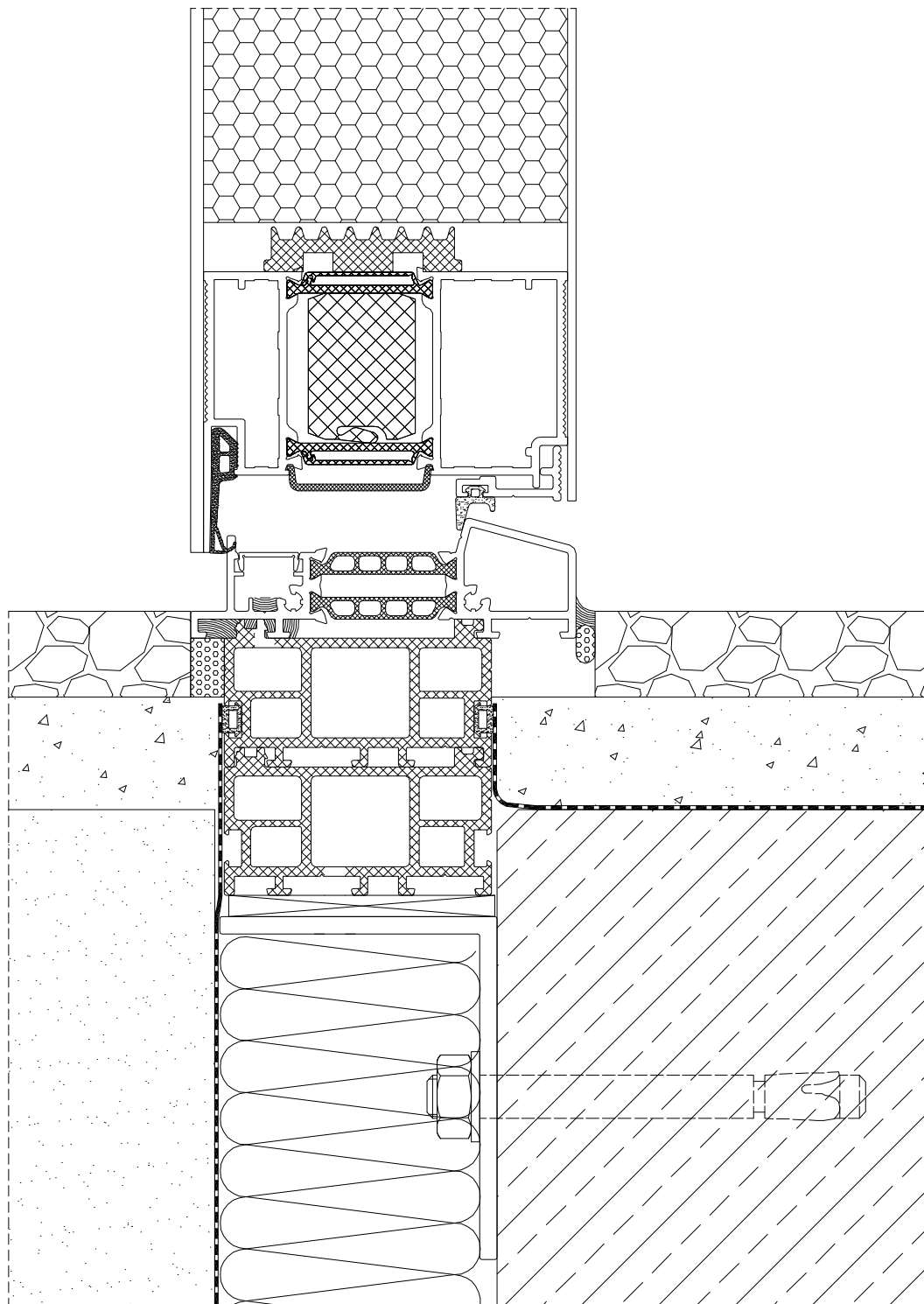

APPLICATION

installation\_14\_06\_2017\_en

APPLICATION

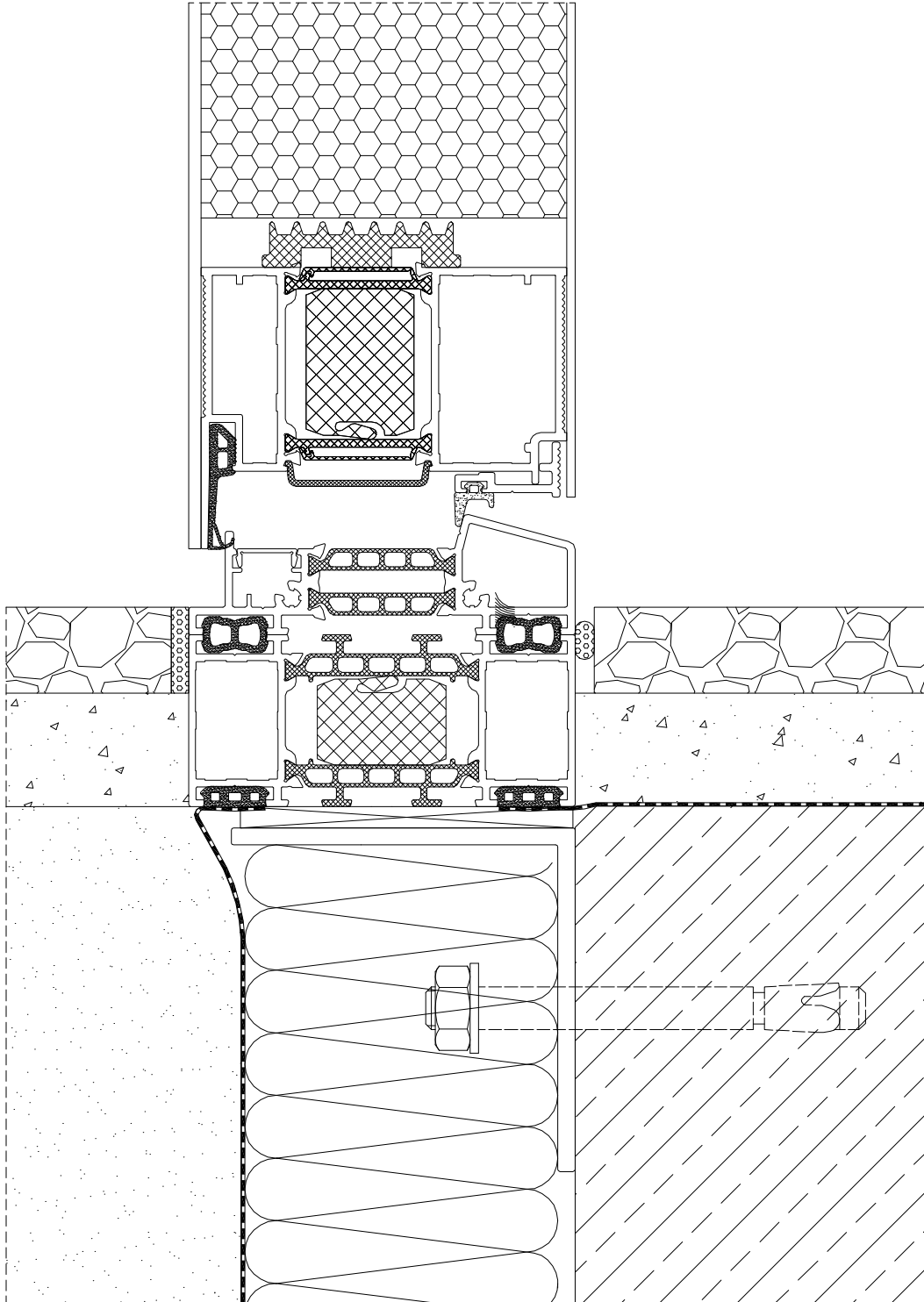

installation\_14\_06\_2017\_en

MO-C-028

16/6/2017

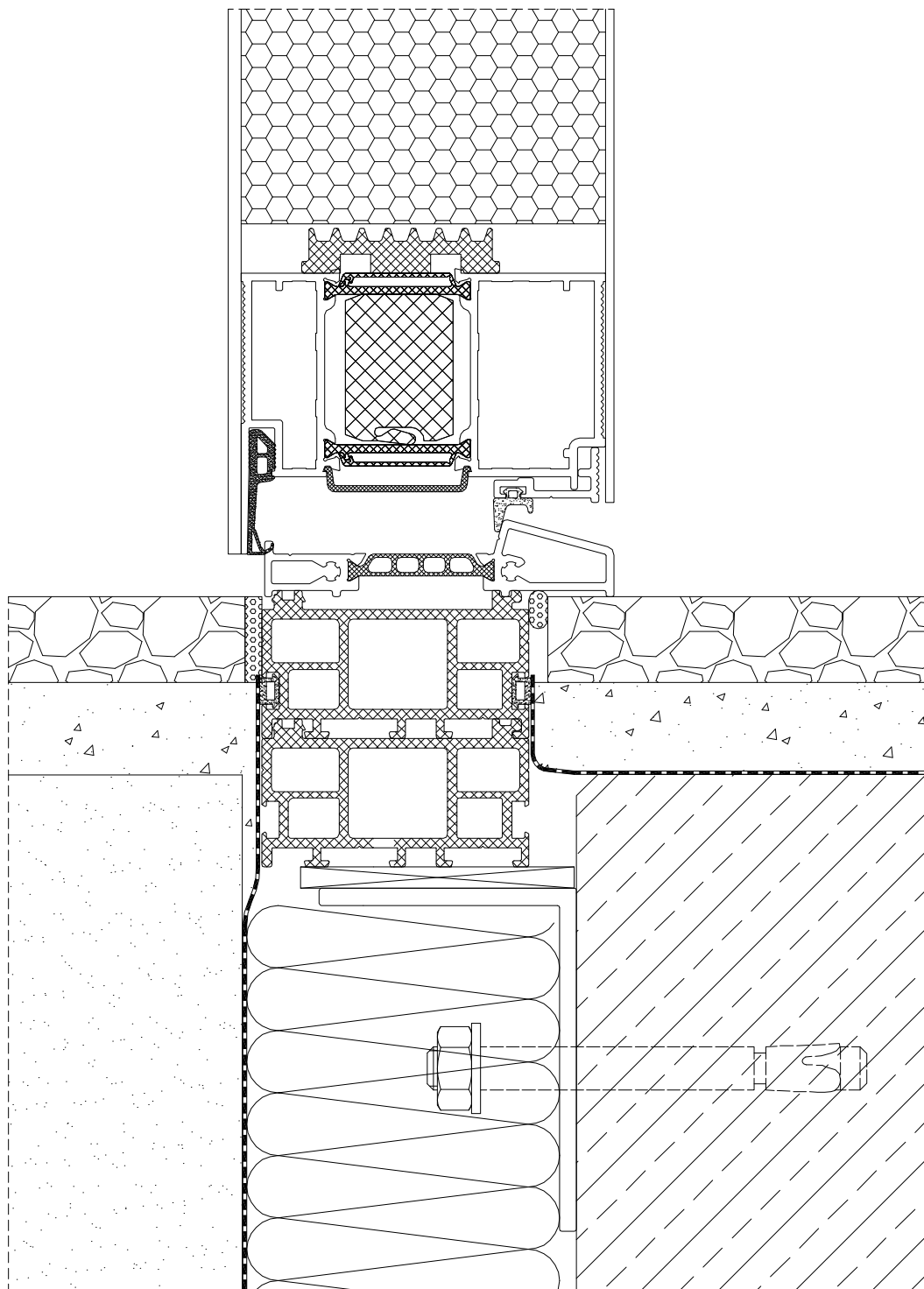

APPLICATION

installation\_14\_06\_2017\_en

APPLICATION

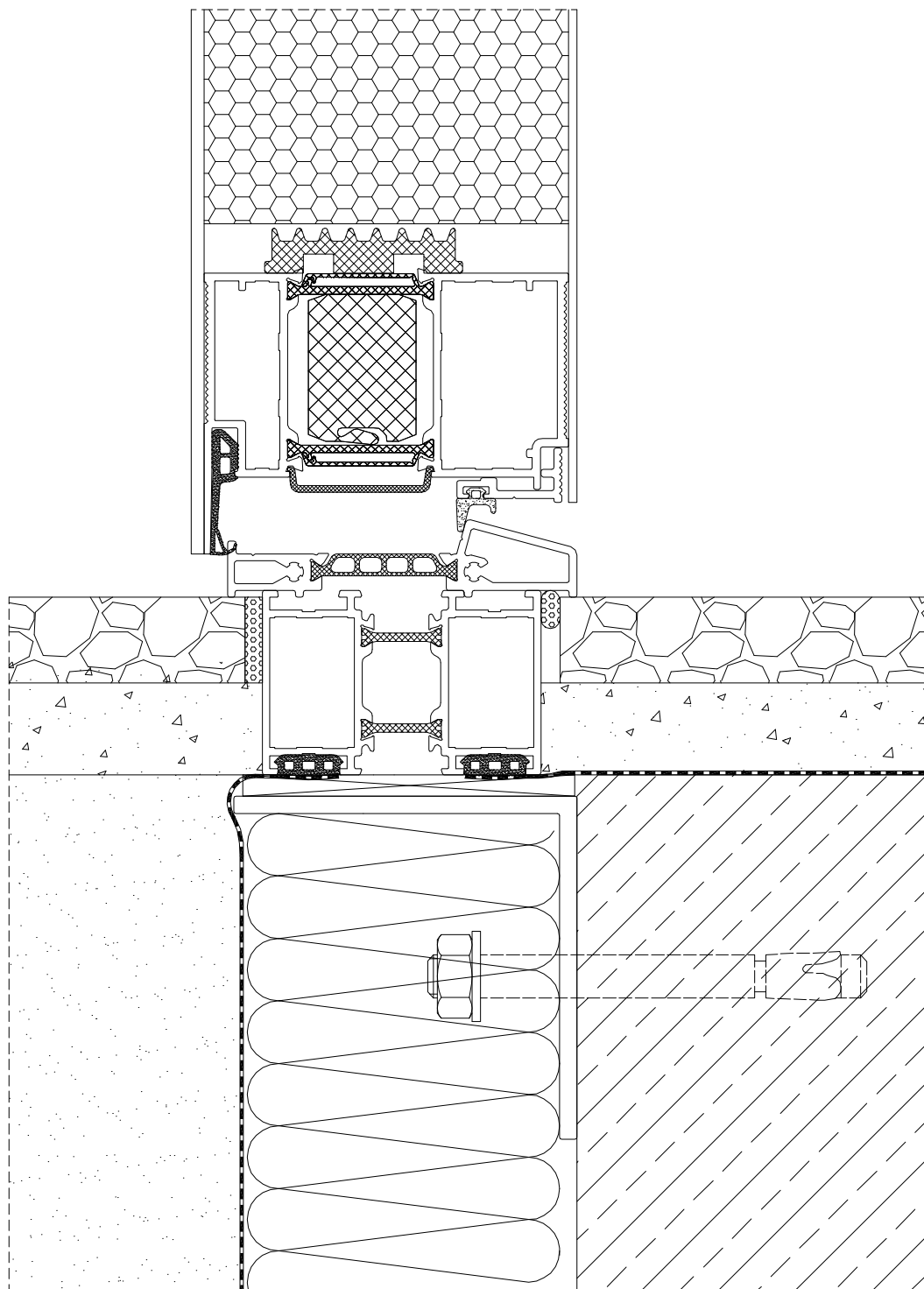

installation\_14\_06\_2017\_en

MO-C-030

16/6/2017



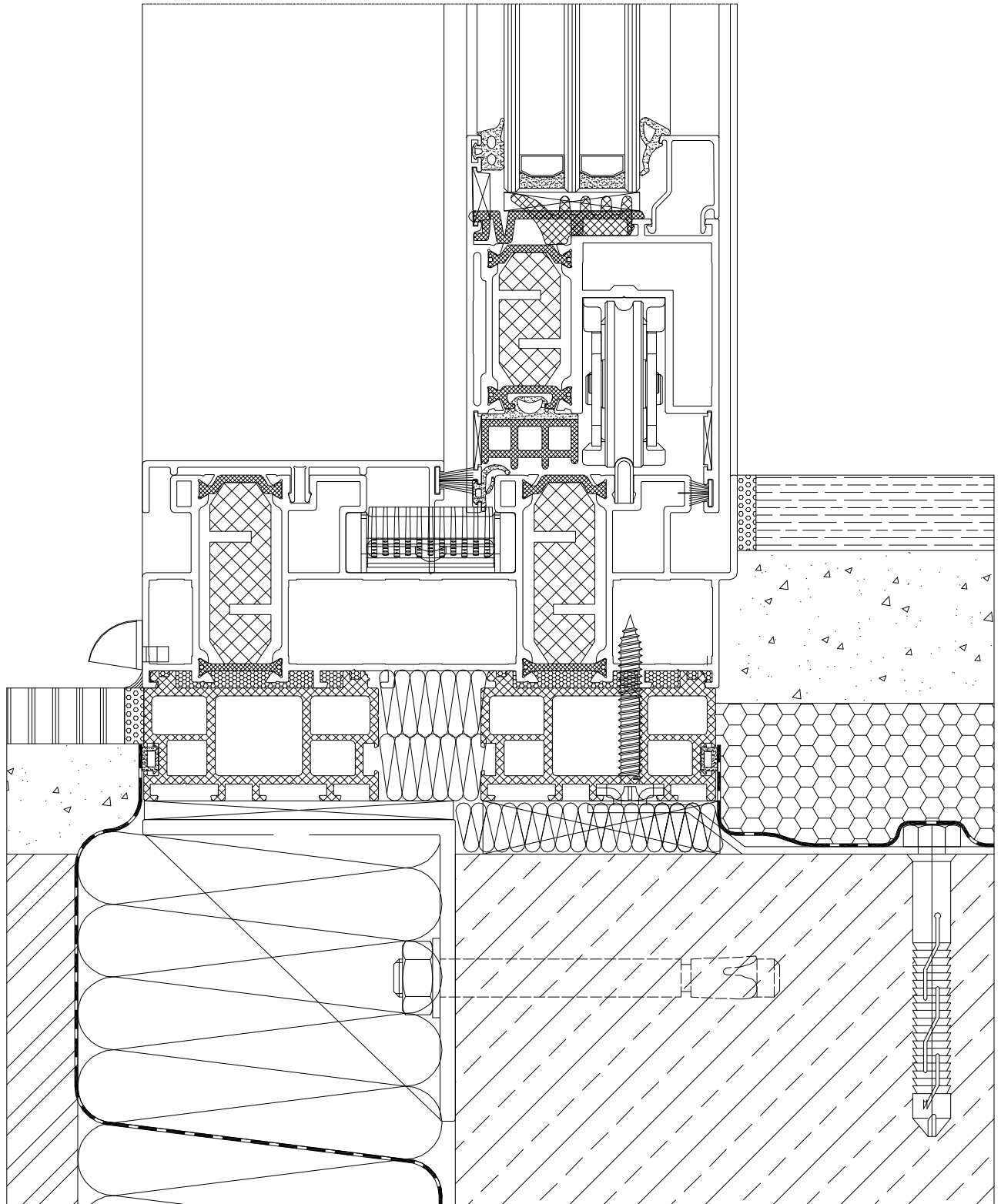

APPLICATION

instalation\_14\_06\_2017\_en

APPLICATION

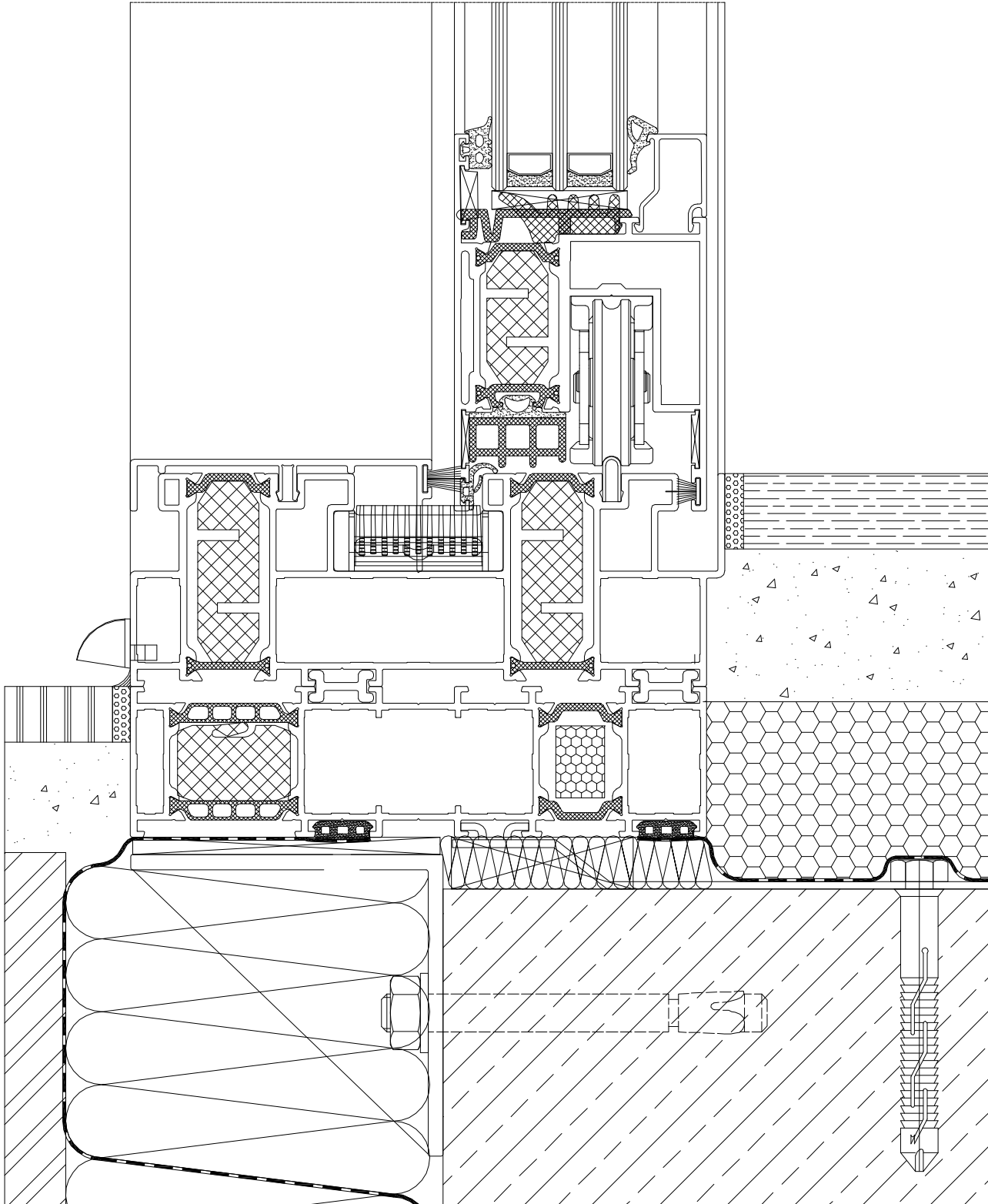

installation\_14\_06\_2017\_en

MO-C-032

16/6/2017

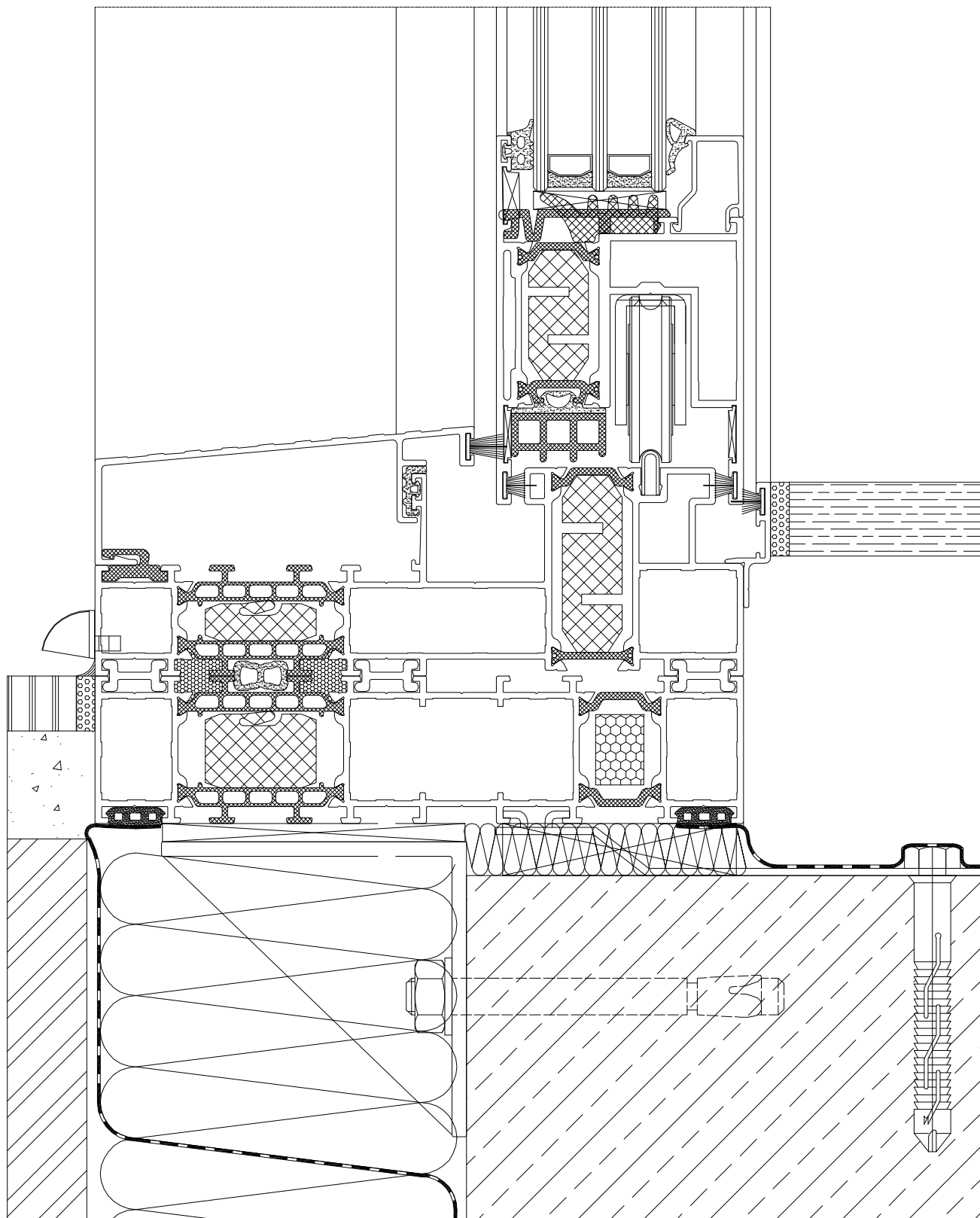

APPLICATION

installation\_14\_06\_2017\_en

APPLICATION

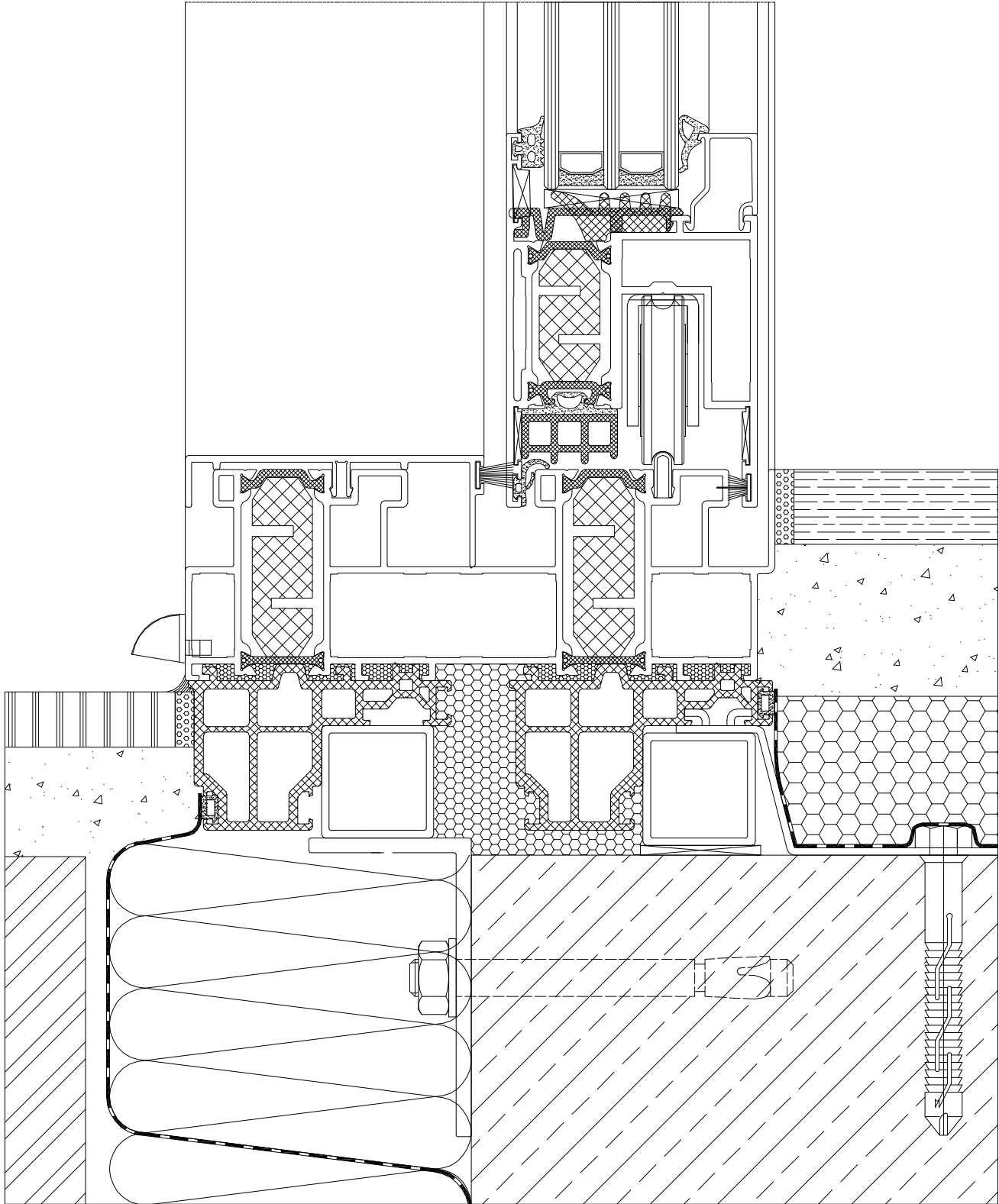

installation\_14\_06\_2017\_en

MO-C-034

16/6/2017

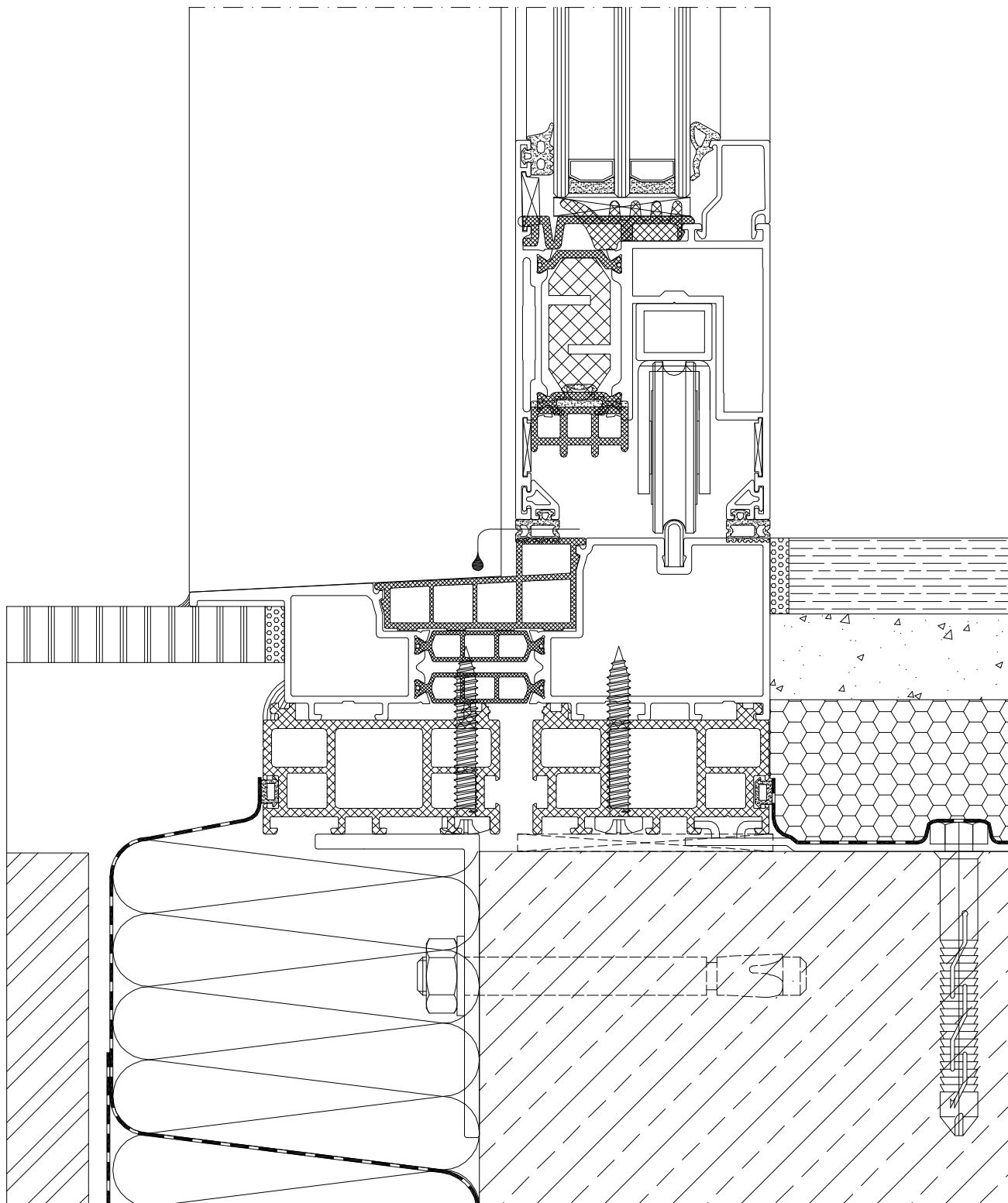

APPLICATION

installation\_14\_06\_2017\_en

APPLICATION

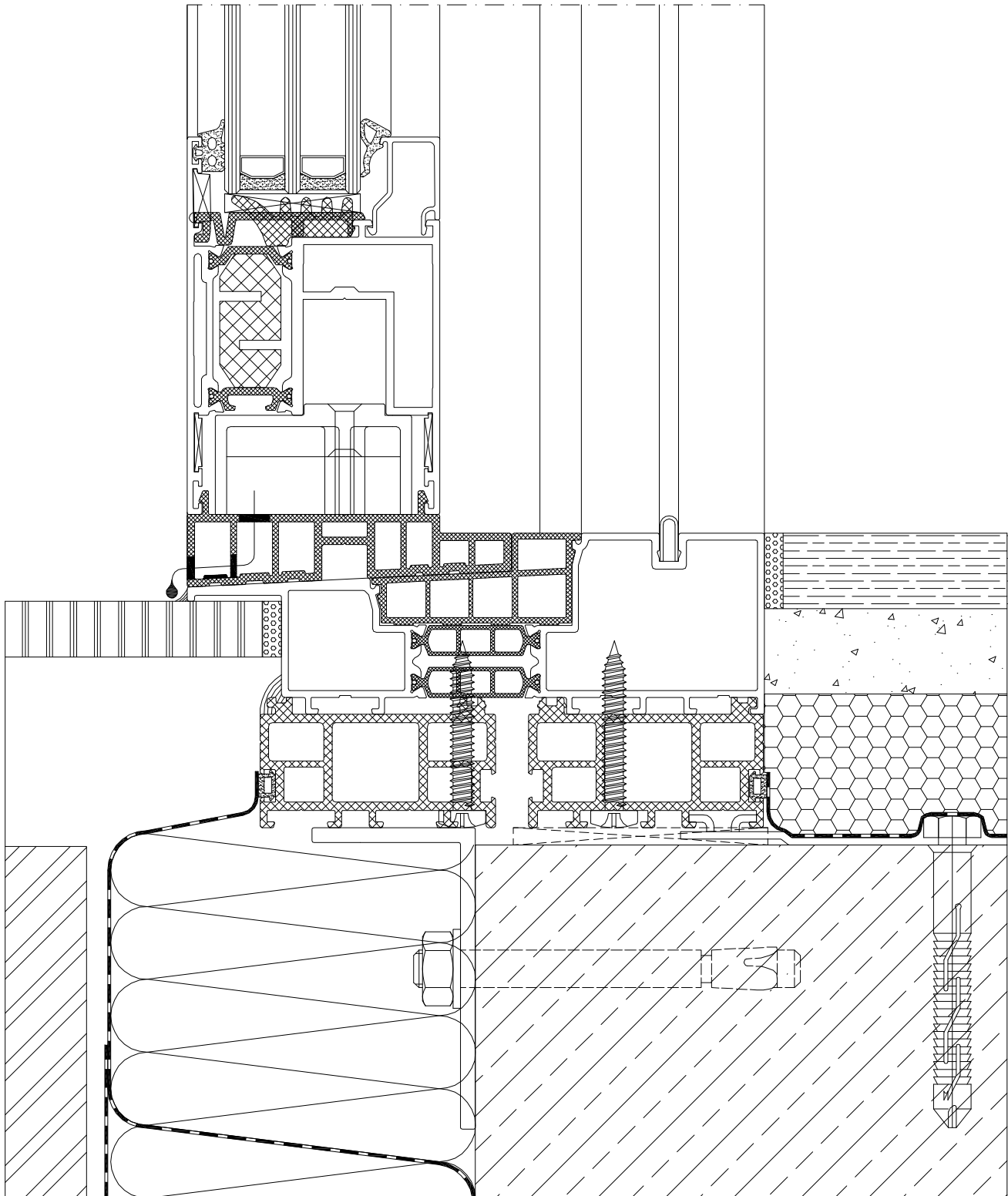

installation\_14\_06\_2017\_en

MO-C-036

16/6/2017

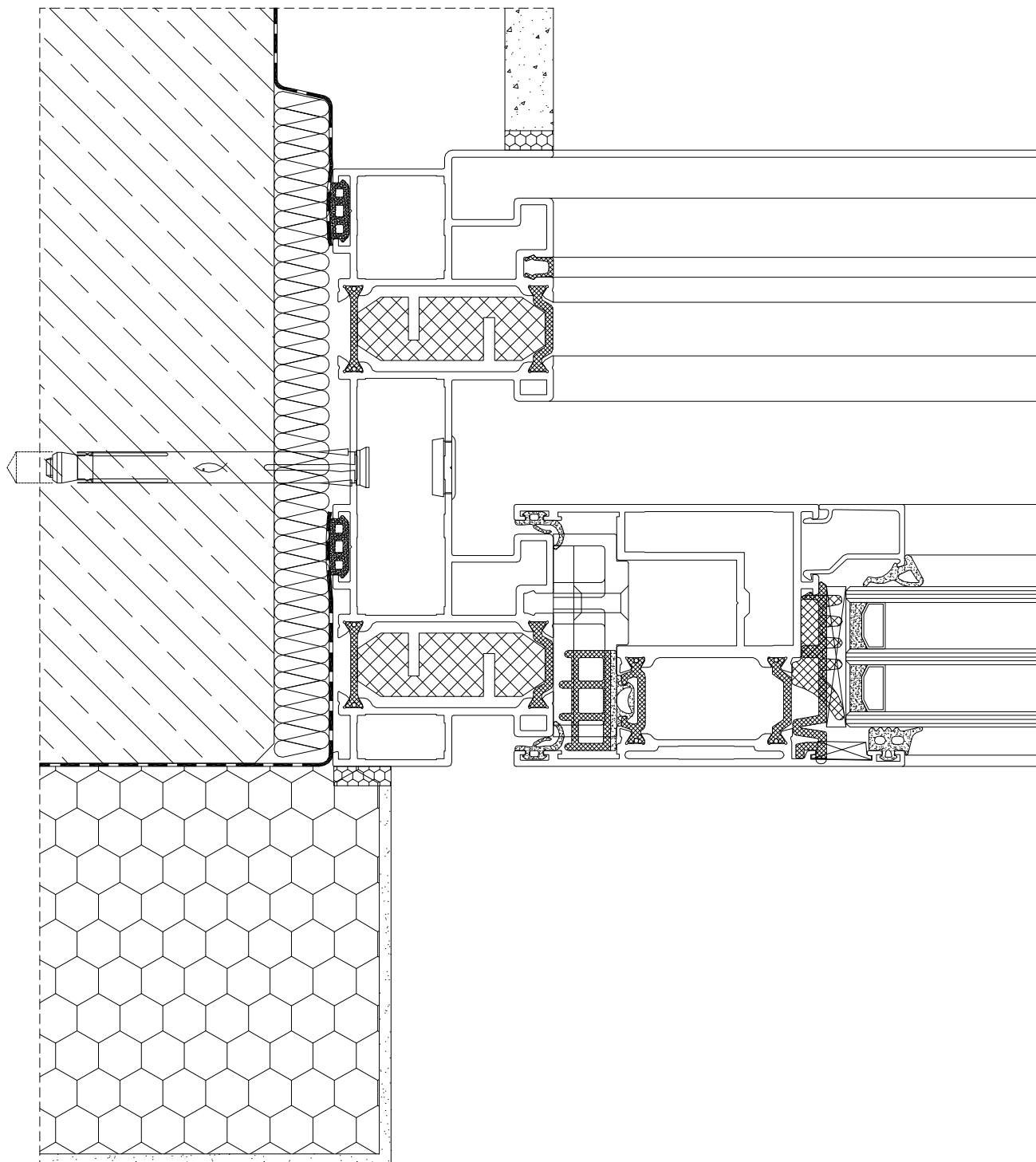

APPLICATION

APPLICATION

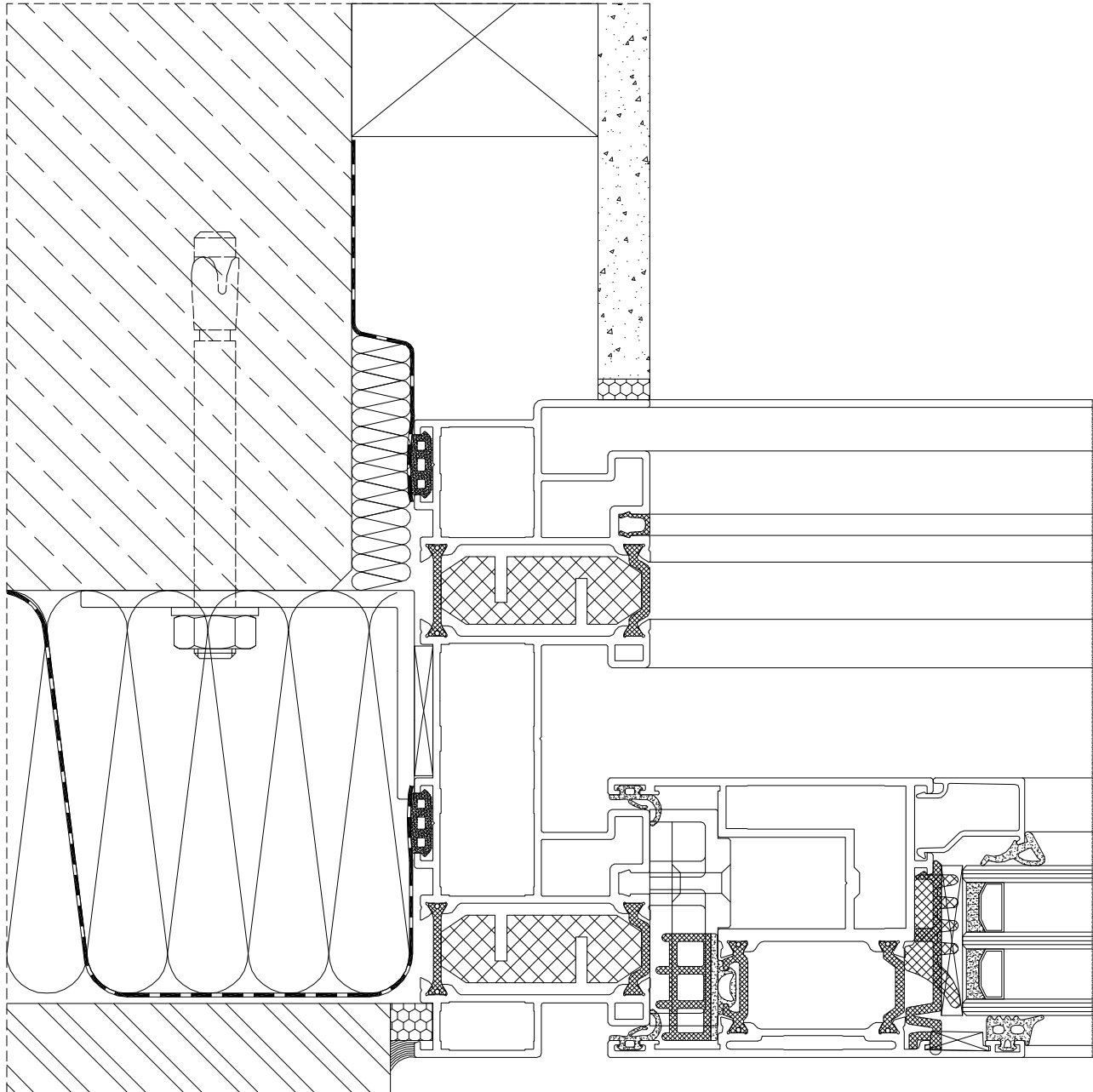

installation\_14\_06\_2017\_en

MO-C-038

16/6/2017



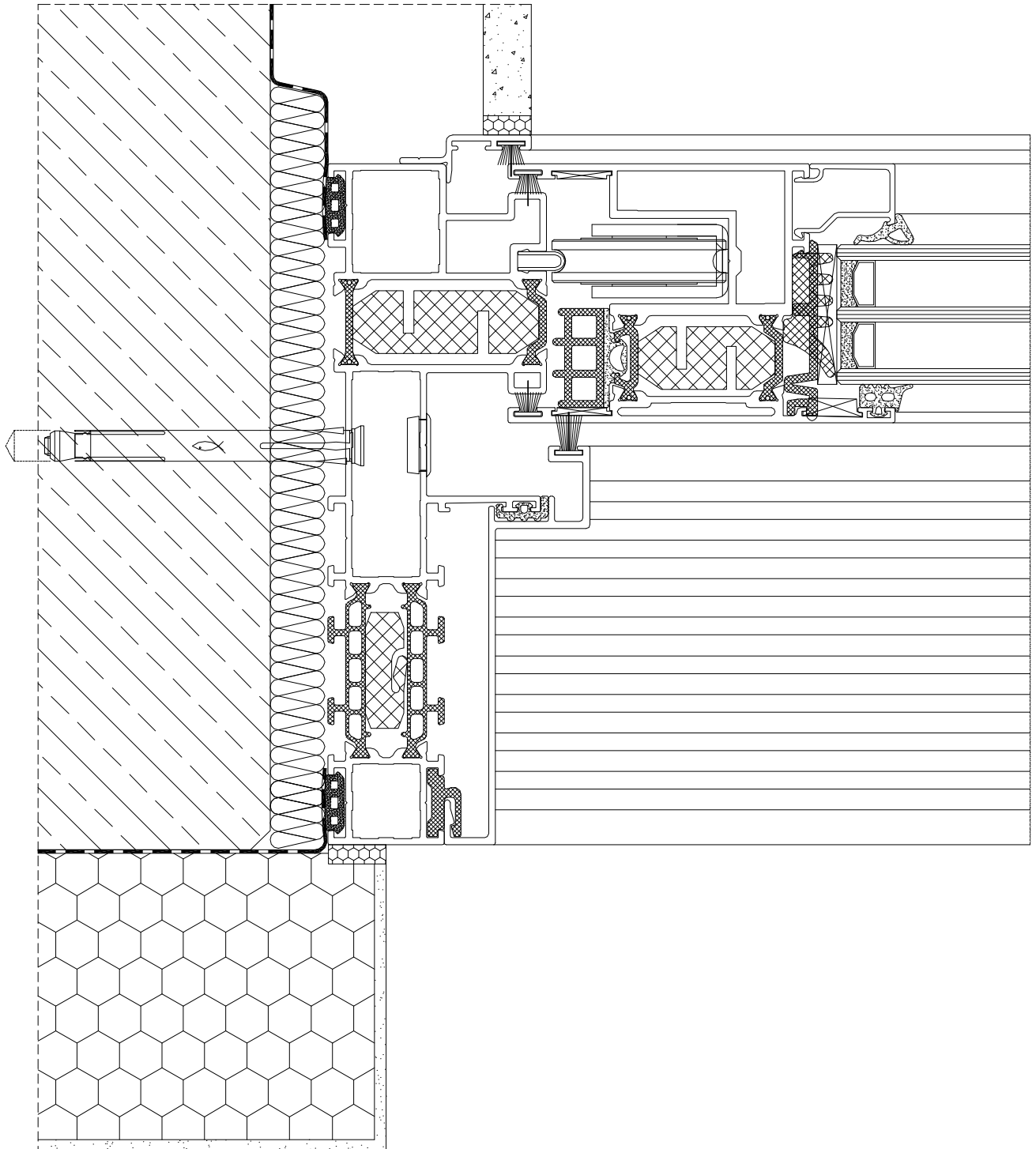

APPLICATION

APPLICATION

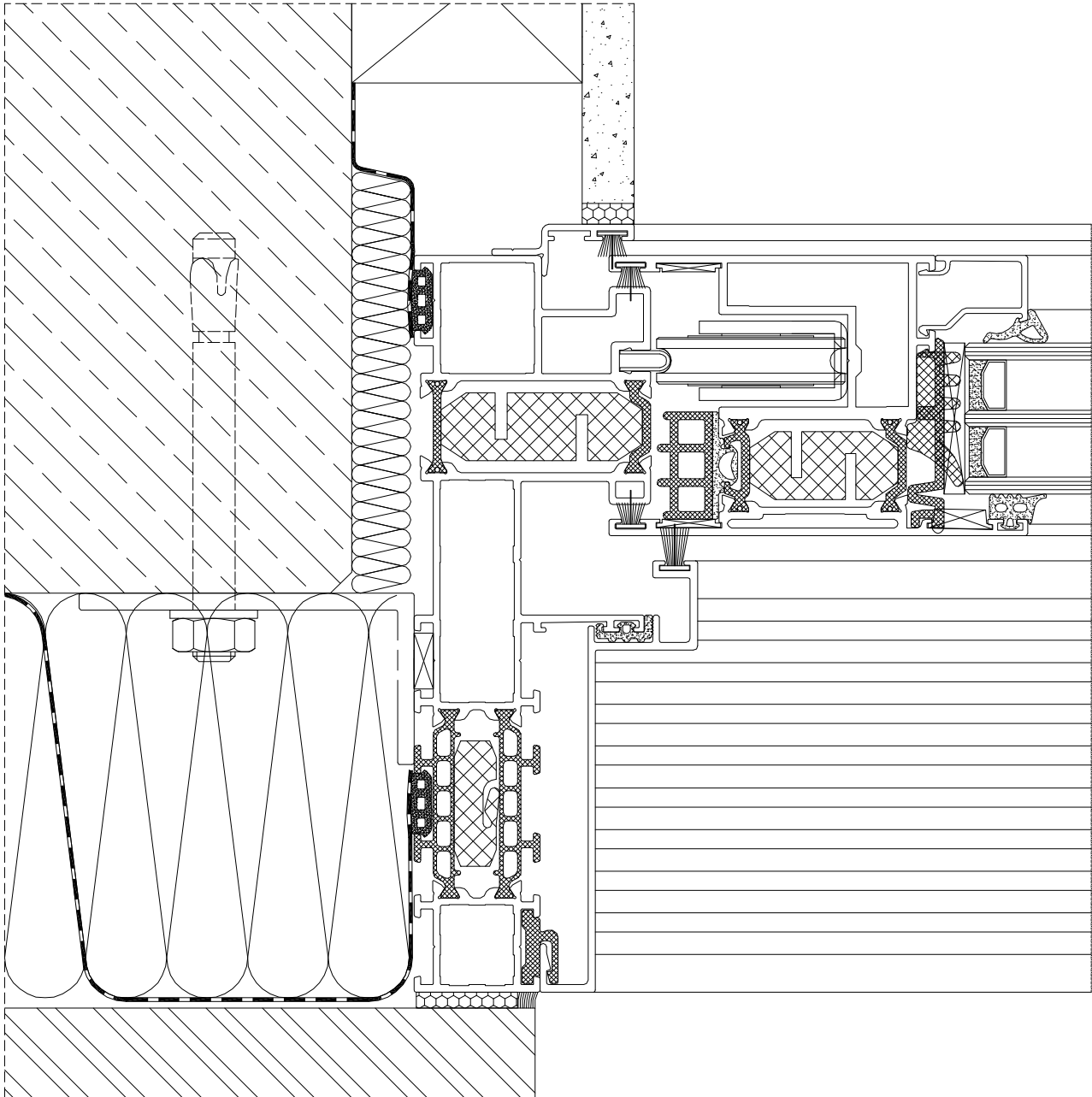

installation\_14\_06\_2017\_en

MO-C-040

16/6/2017

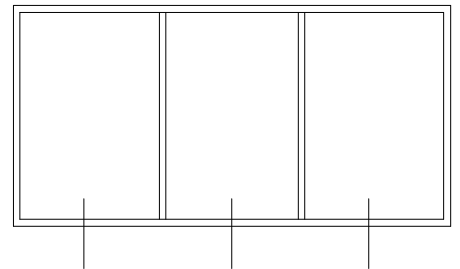
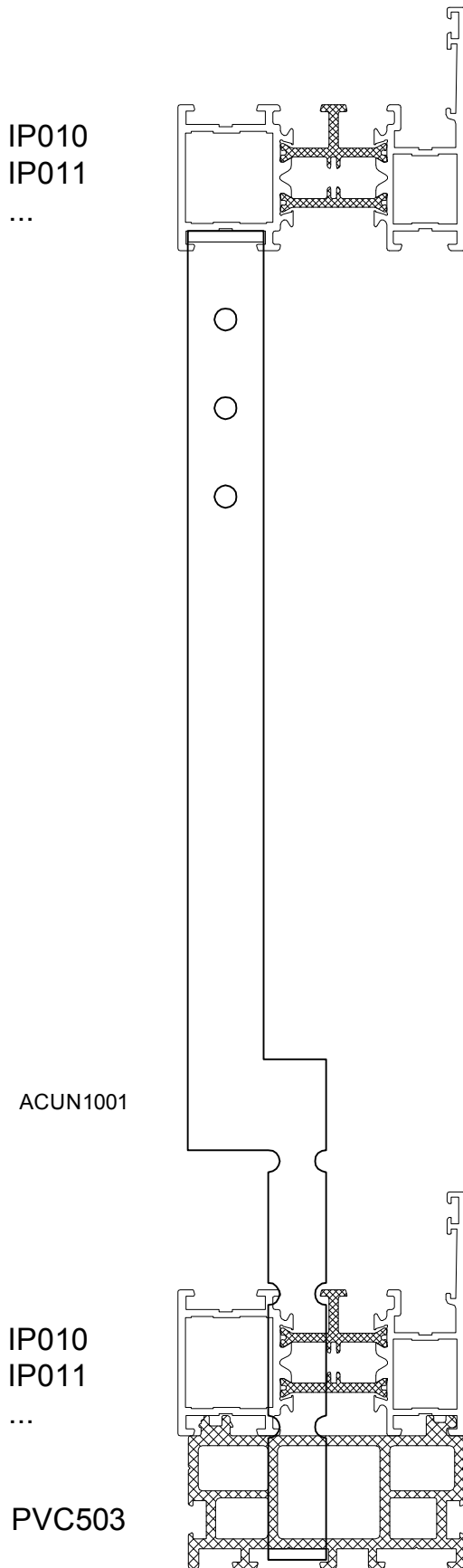

INSTALLATION GUIDELINES

INSTALLATION GUIDELINES

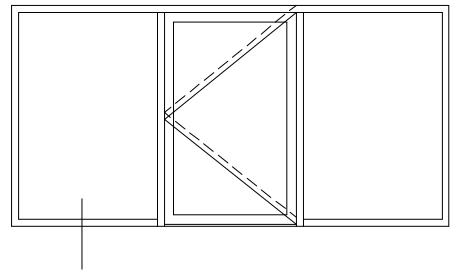
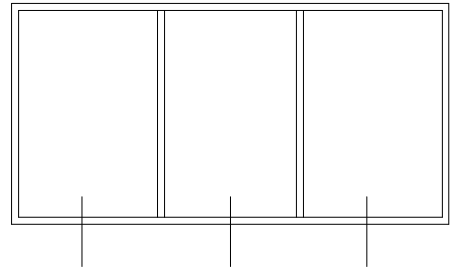
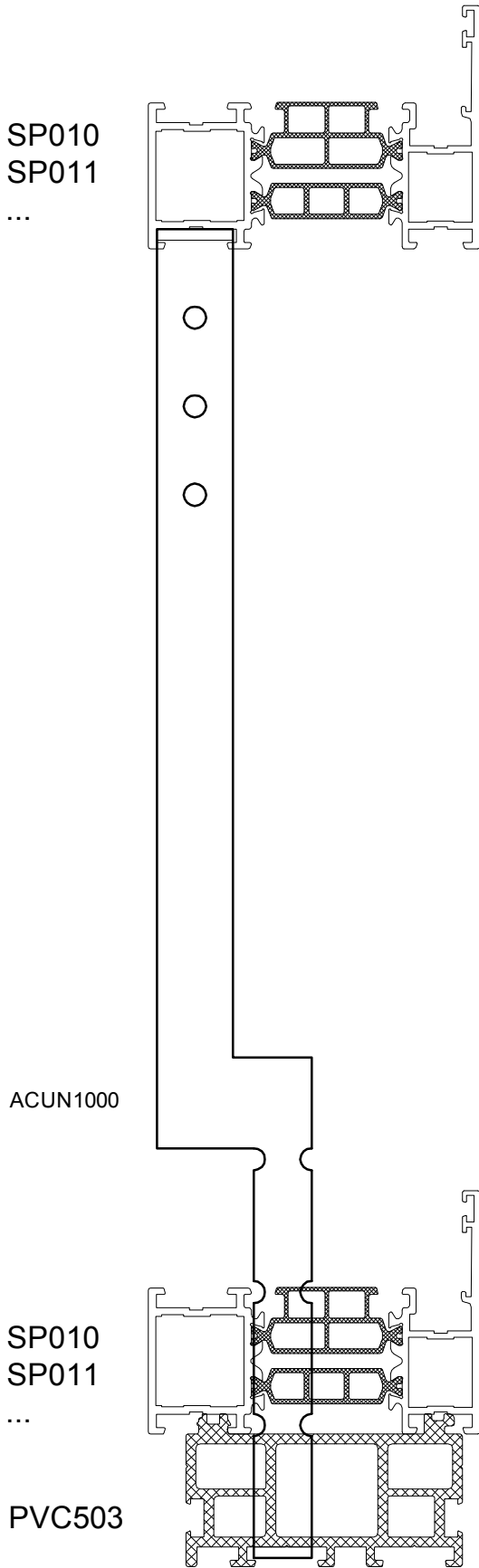

Installation\_14\_06\_2017\_en

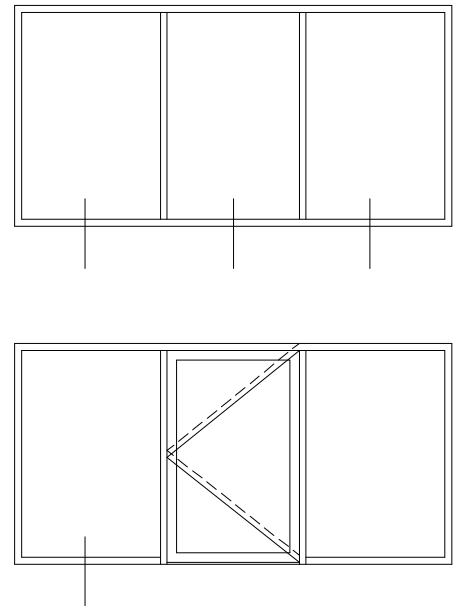
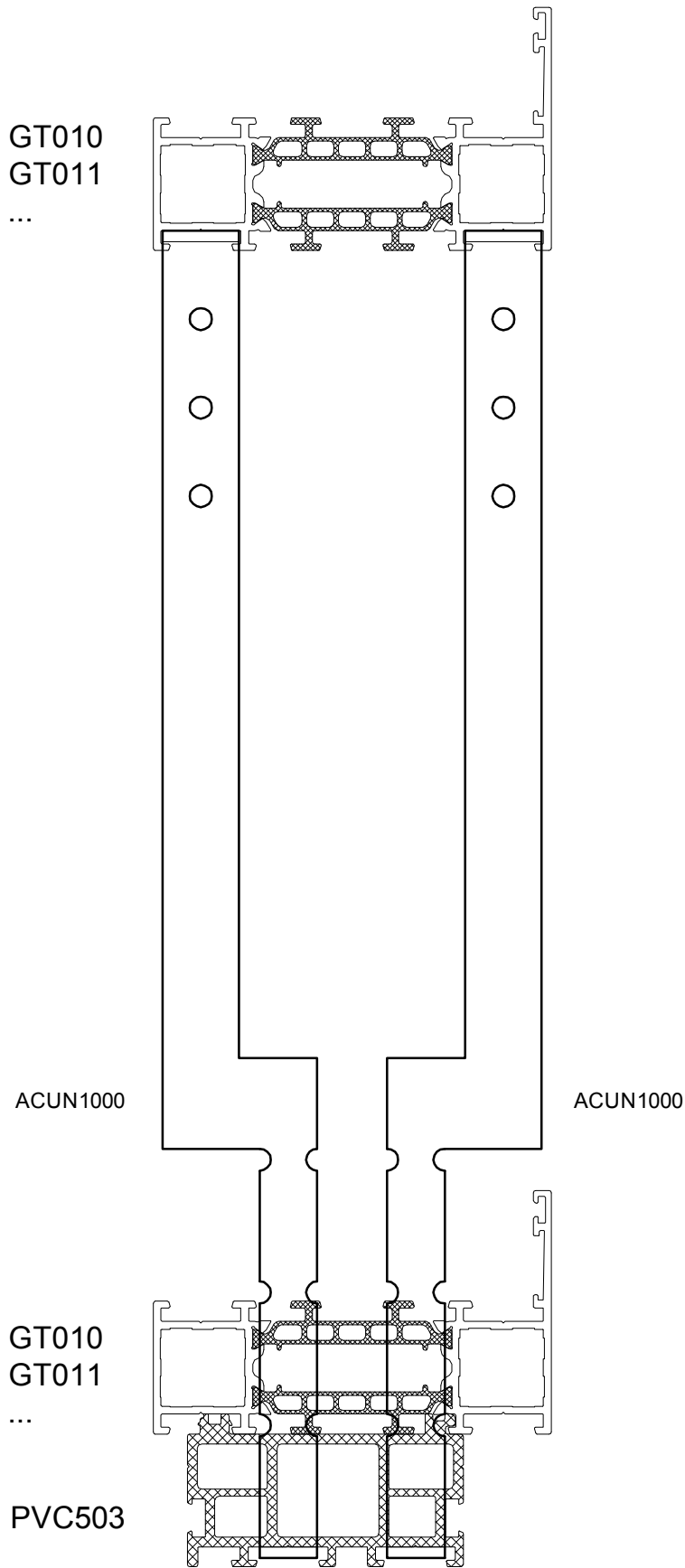

INSTALLATION GUIDELINES

# INSTALLATION

INSTALLATION GUIDELINES

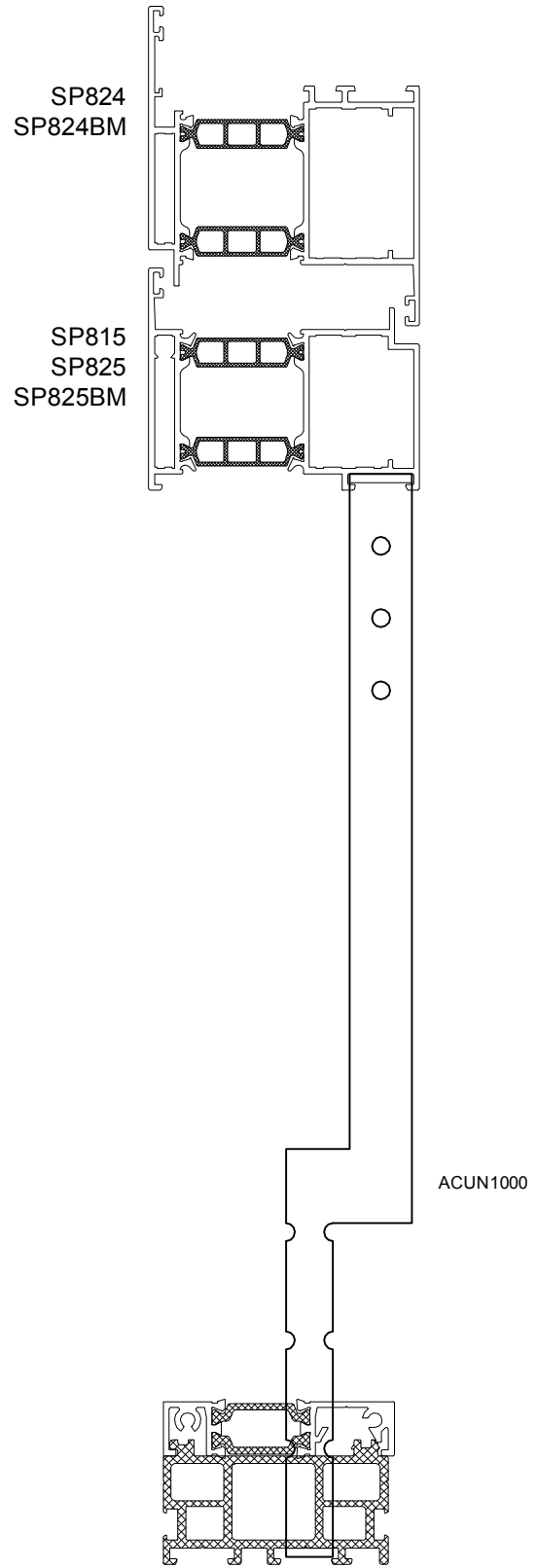
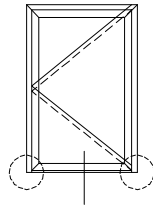
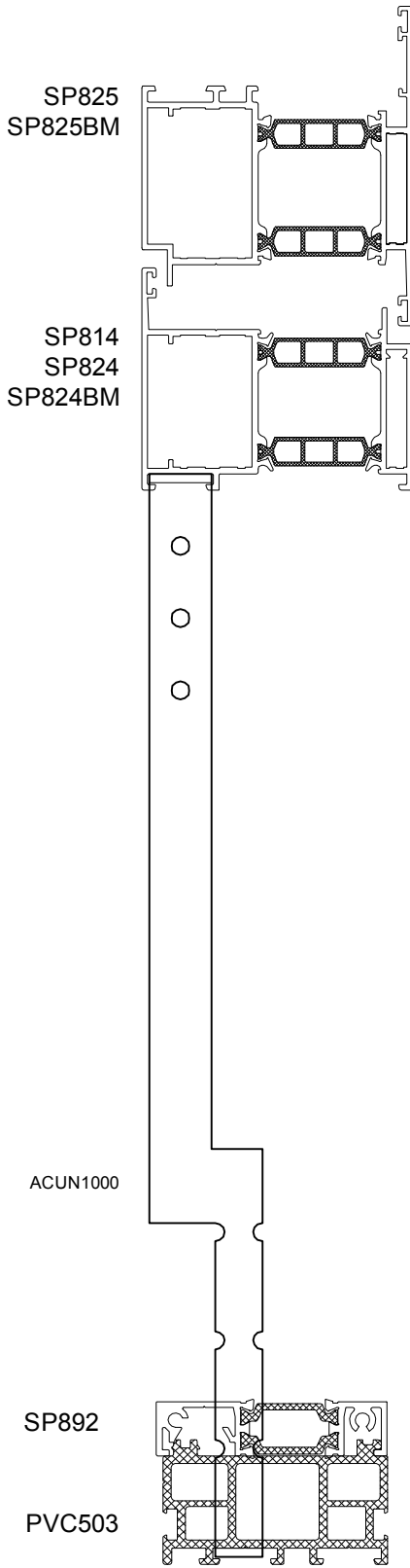

Installation\_14\_06\_2017\_en

MO-E-004

16/6/2017

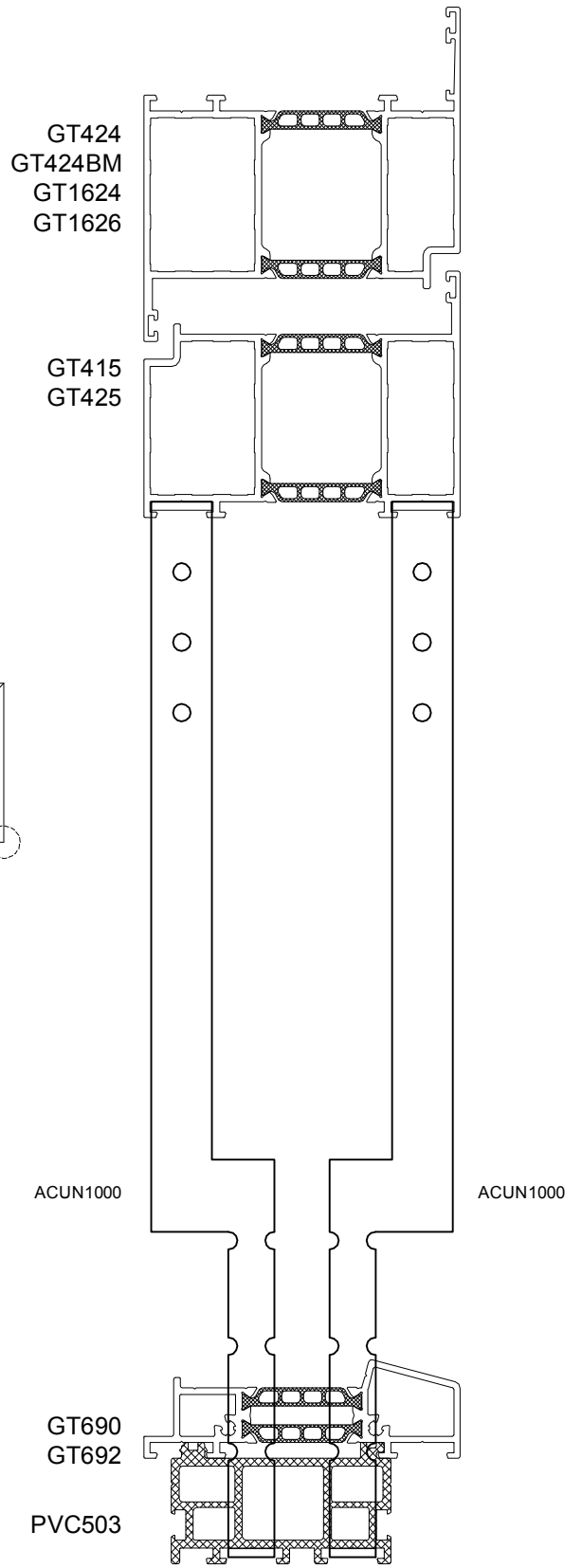
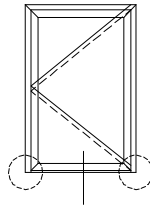
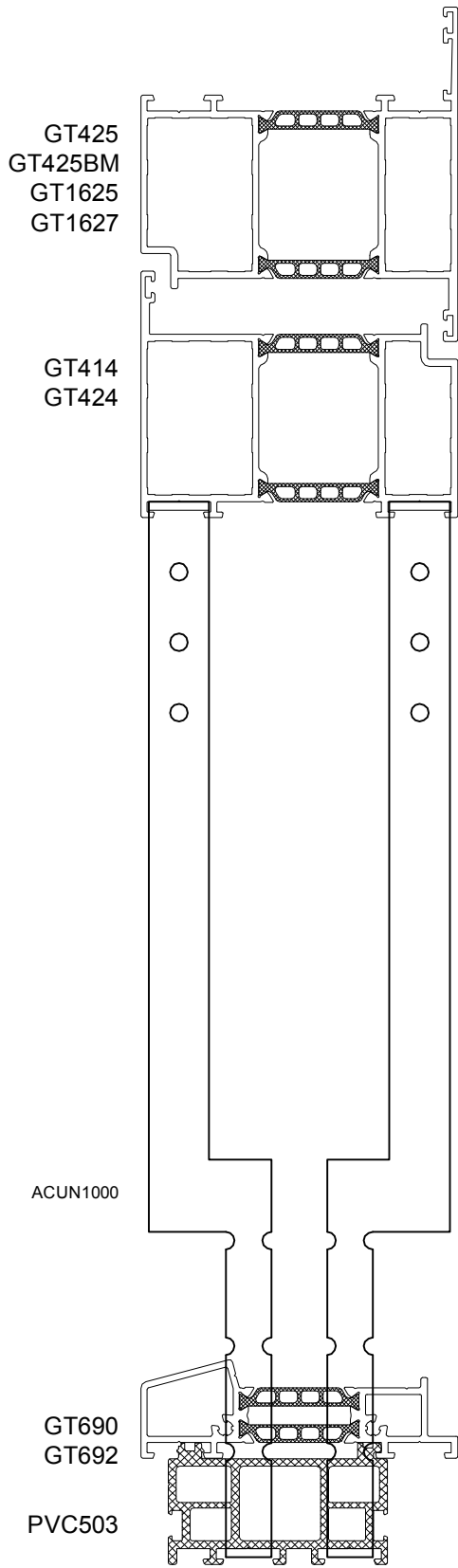

INSTALLATION GUIDELINES

installation\_14\_06\_2017\_en

INSTALLATION GUIDELINES

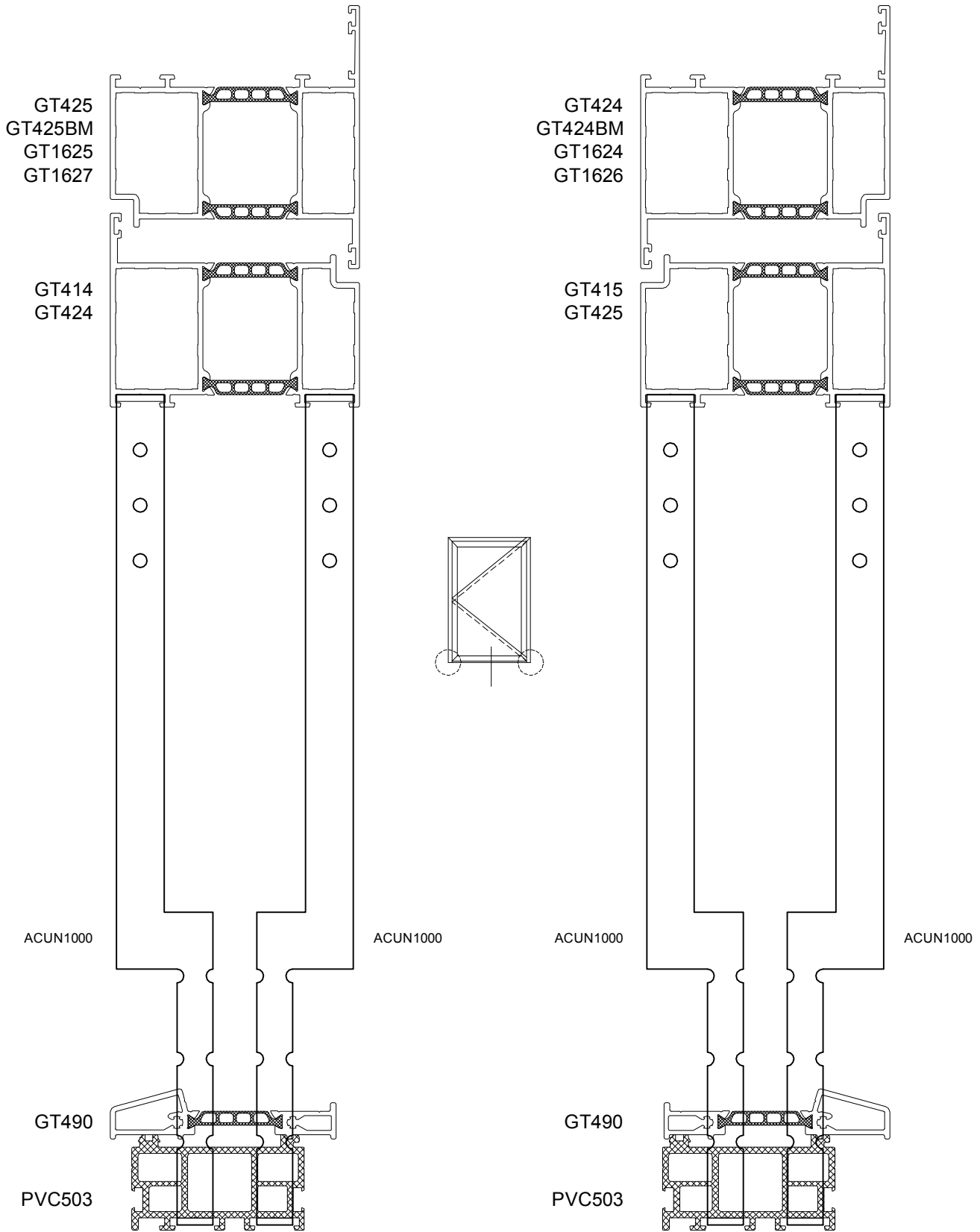

Installation\_14\_06\_2017\_en



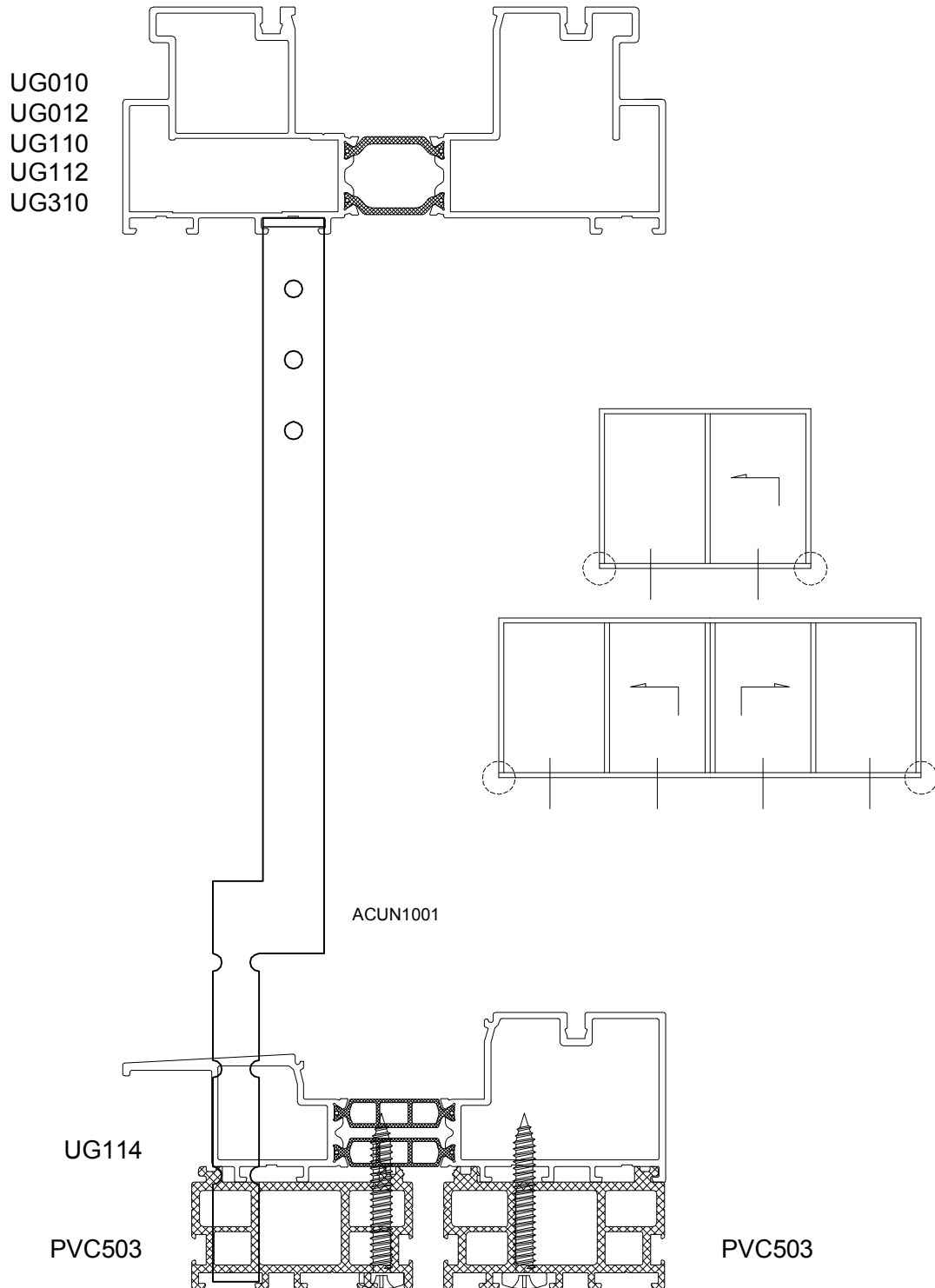

INSTALLATION GUIDELINES

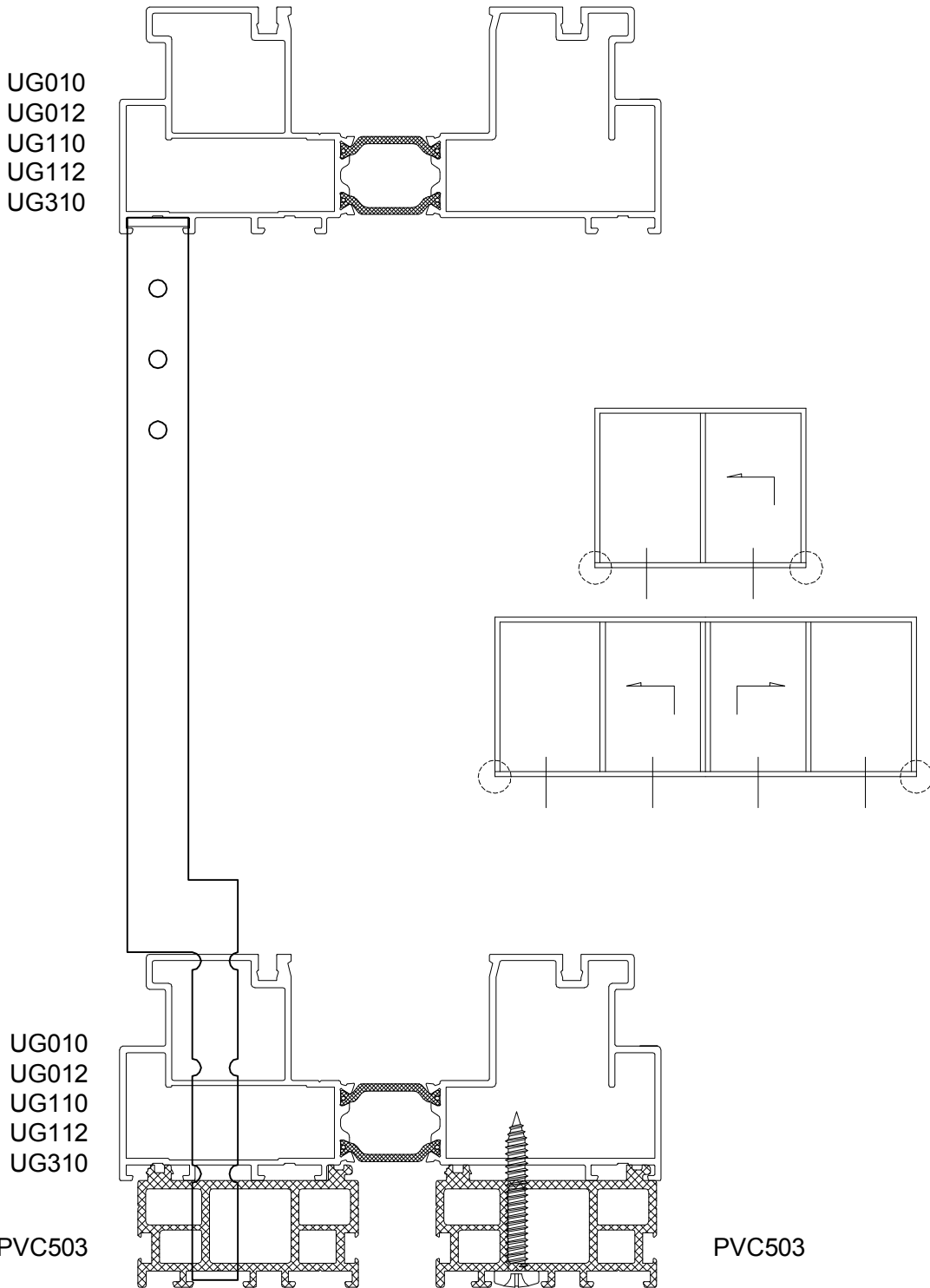

INSTALLATION GUIDELINES

Installation\_14\_06\_2017\_en

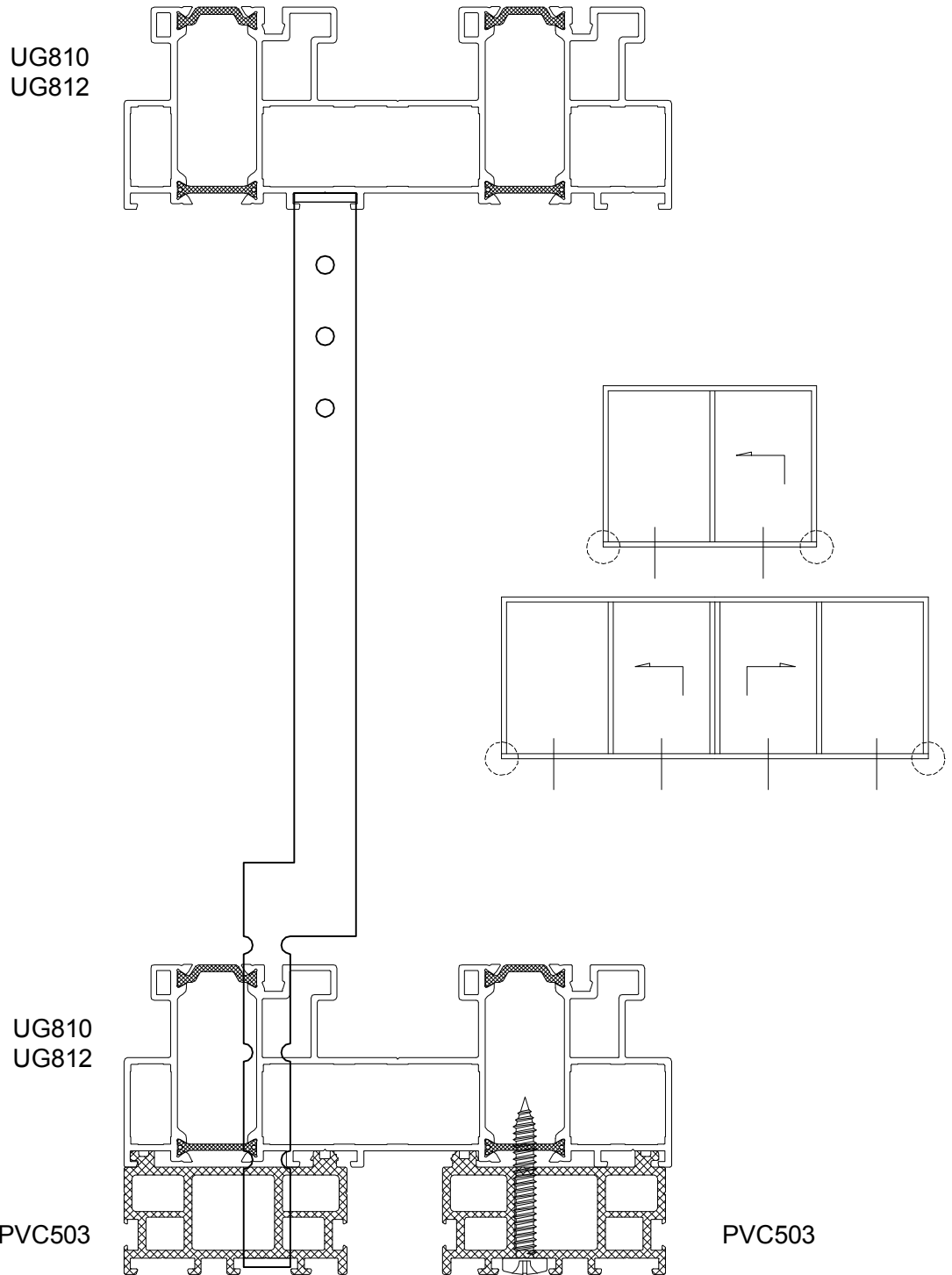

INSTALLATION GUIDELINES

INSTALLATION GUIDELINES

UG810  
UG812

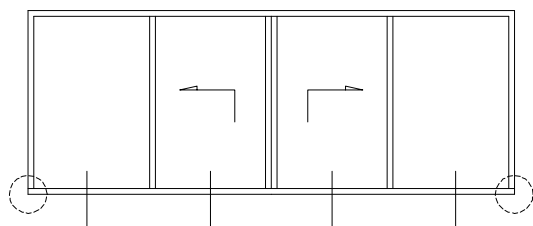
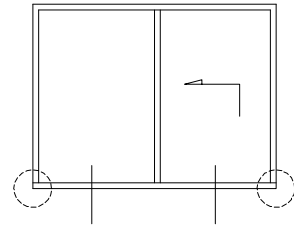
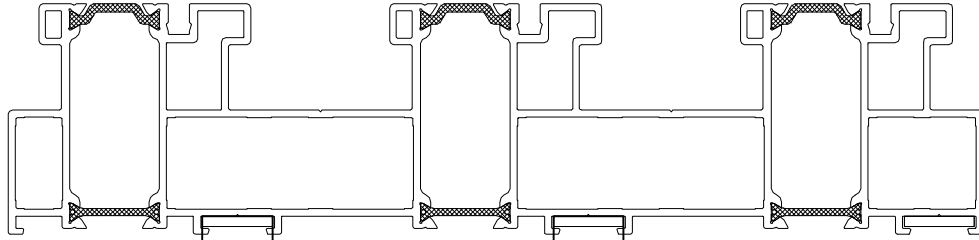

UG810  
UG812

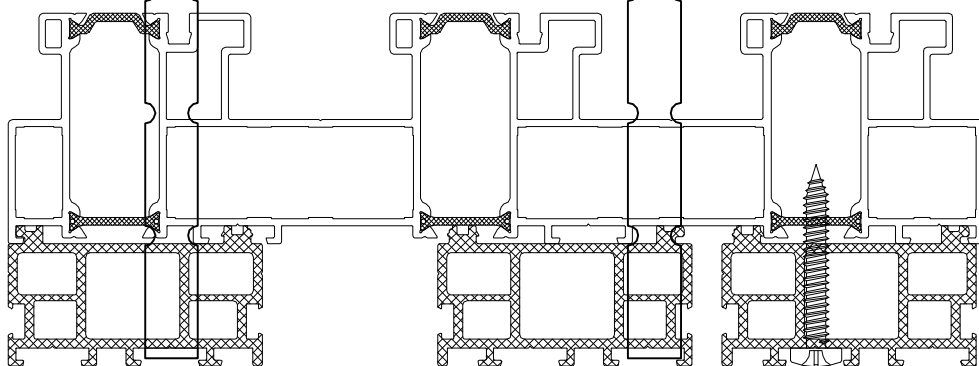

PVC503

PVC503

Installation\_14\_06\_2017\_en

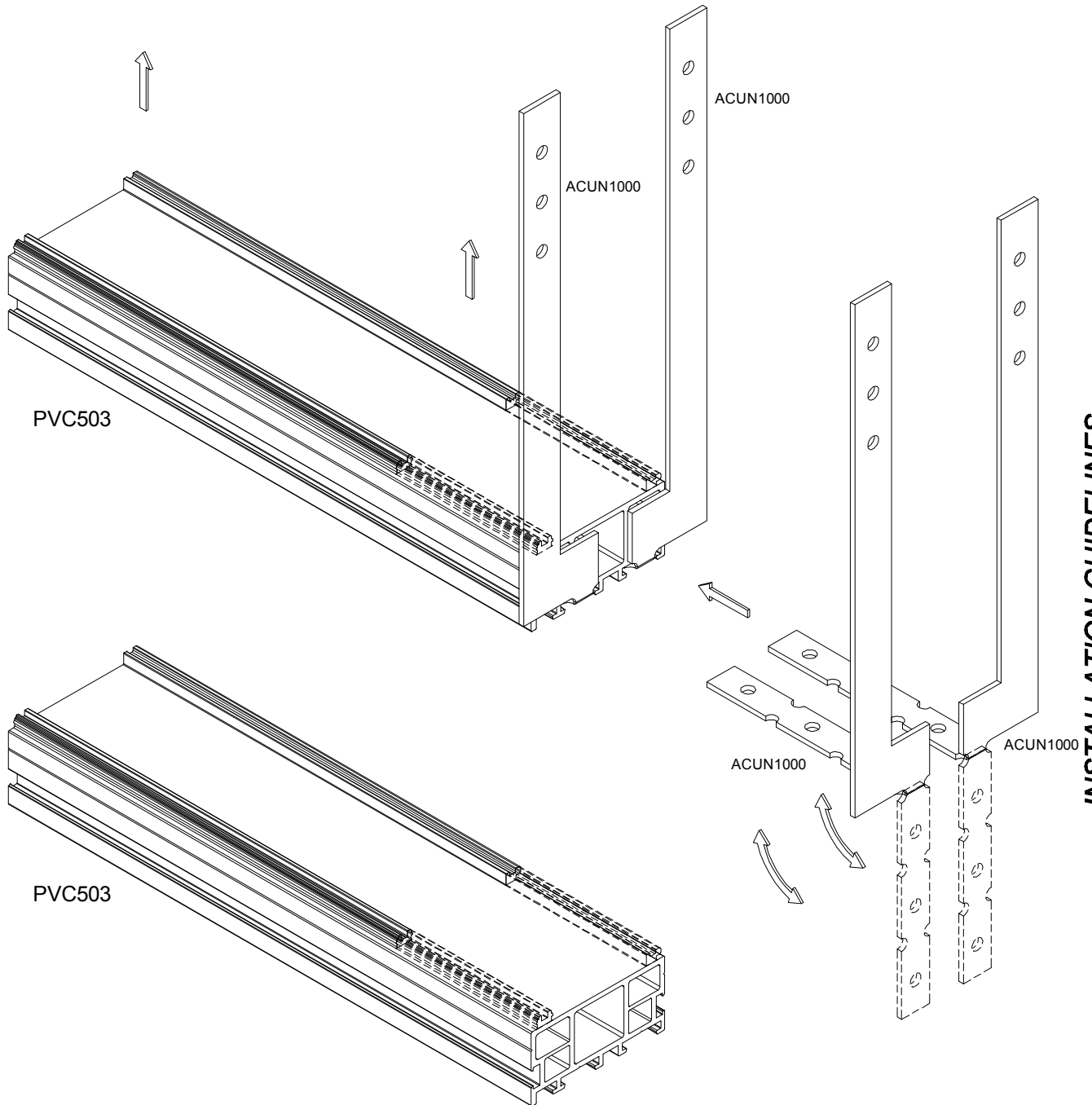

INSTALLATION GUIDELINES

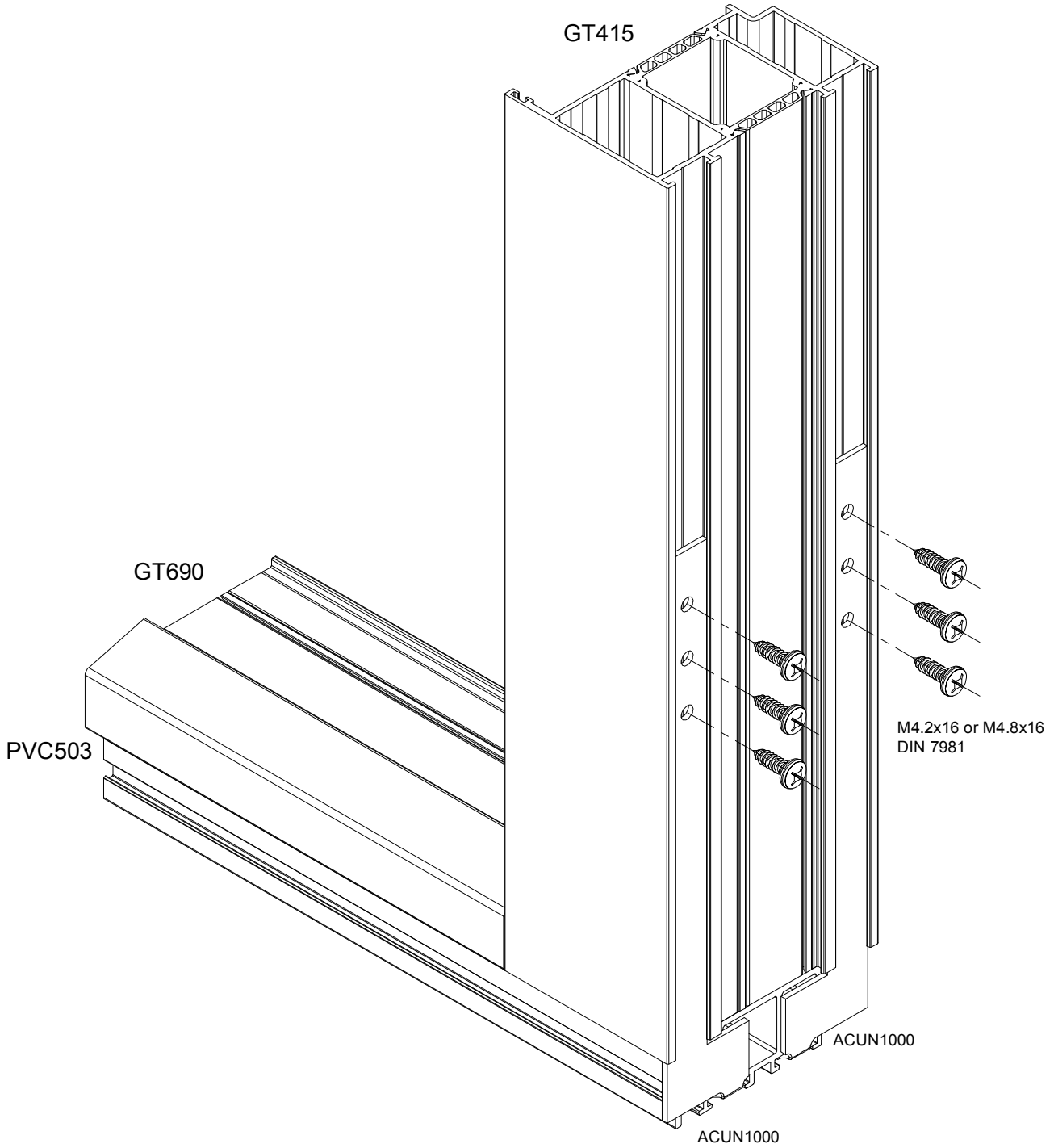

Installation\_14\_06\_2017\_en

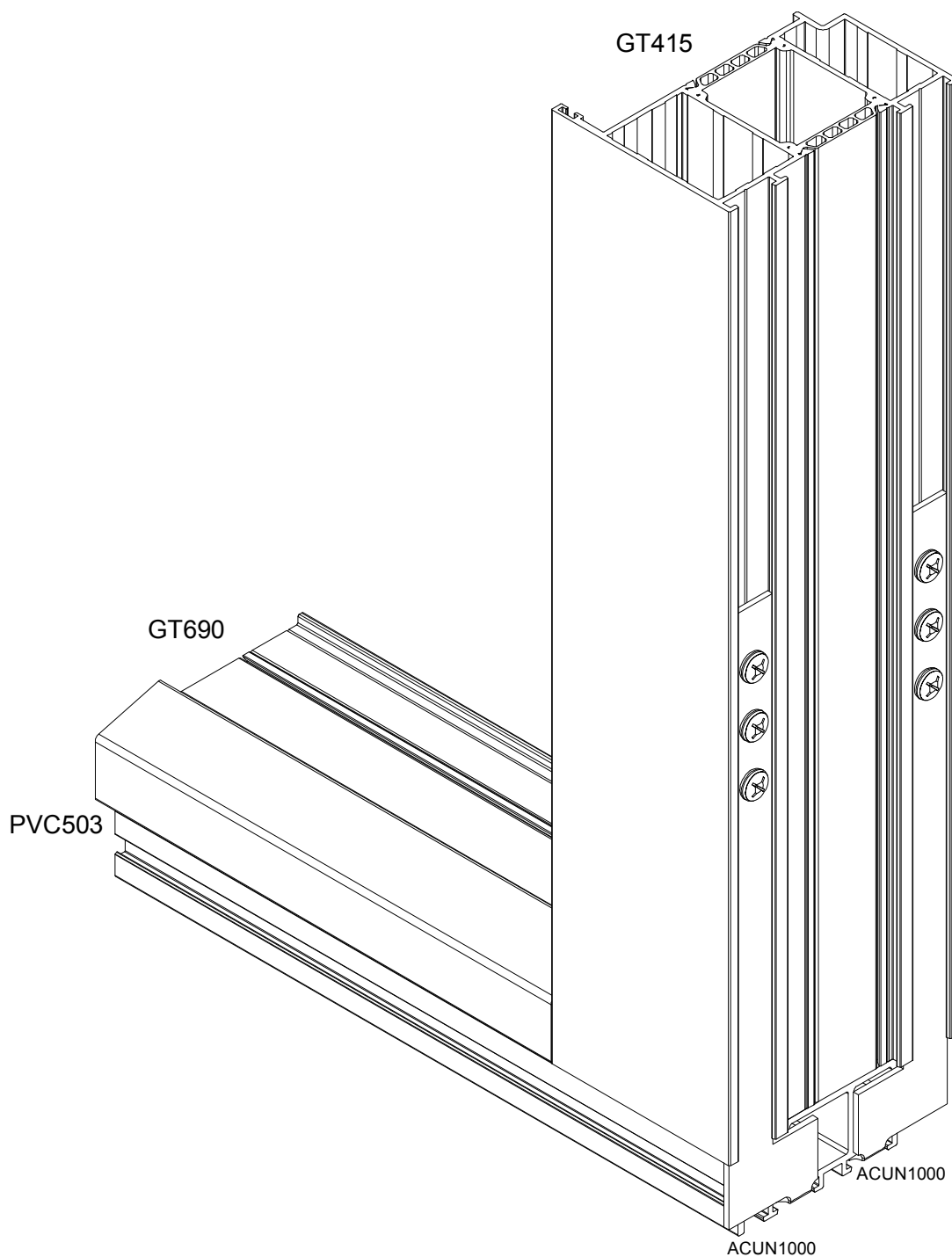

INSTALLATION GUIDELINES

INSTALLATION GUIDELINES

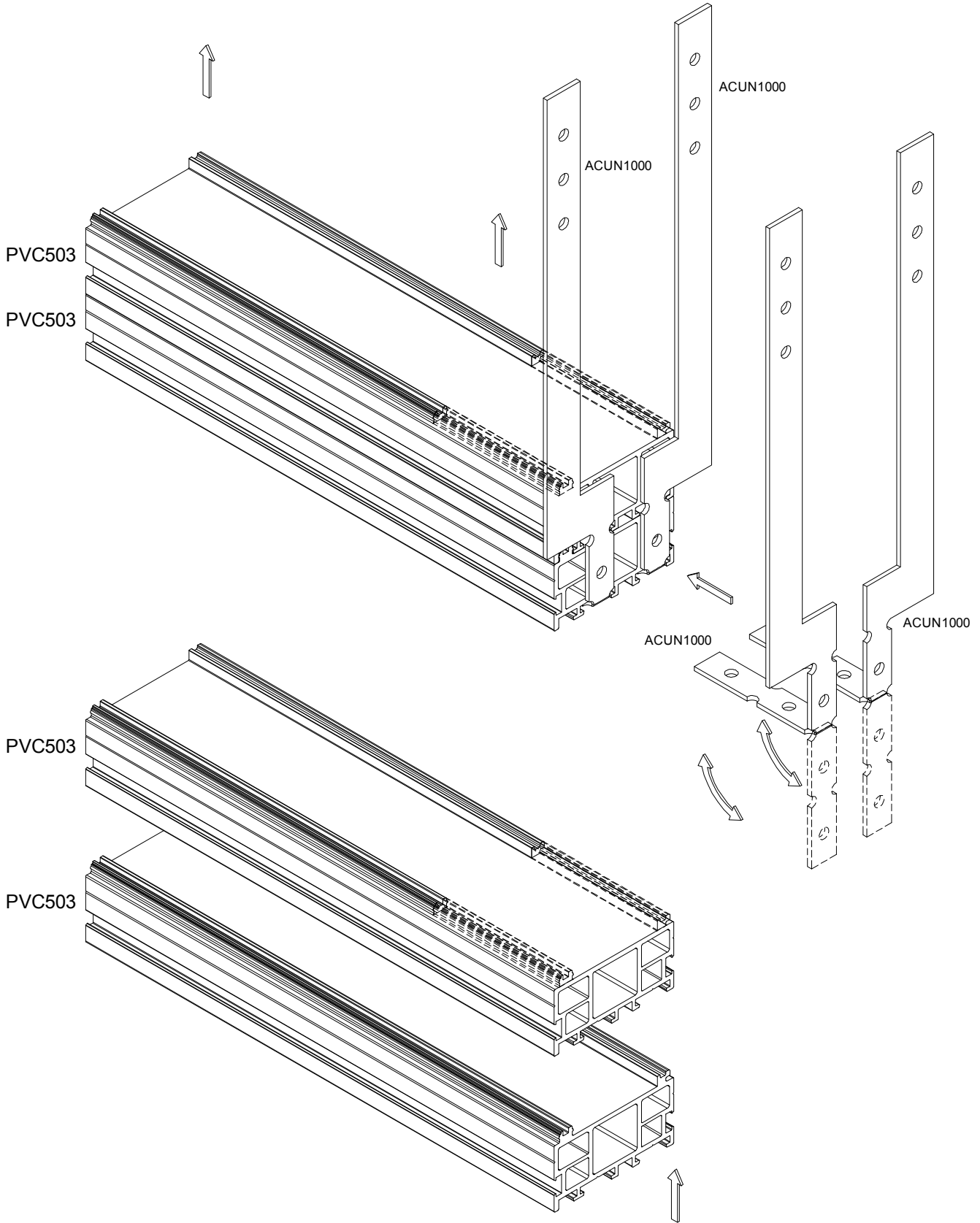

Installation\_14\_06\_2017\_en



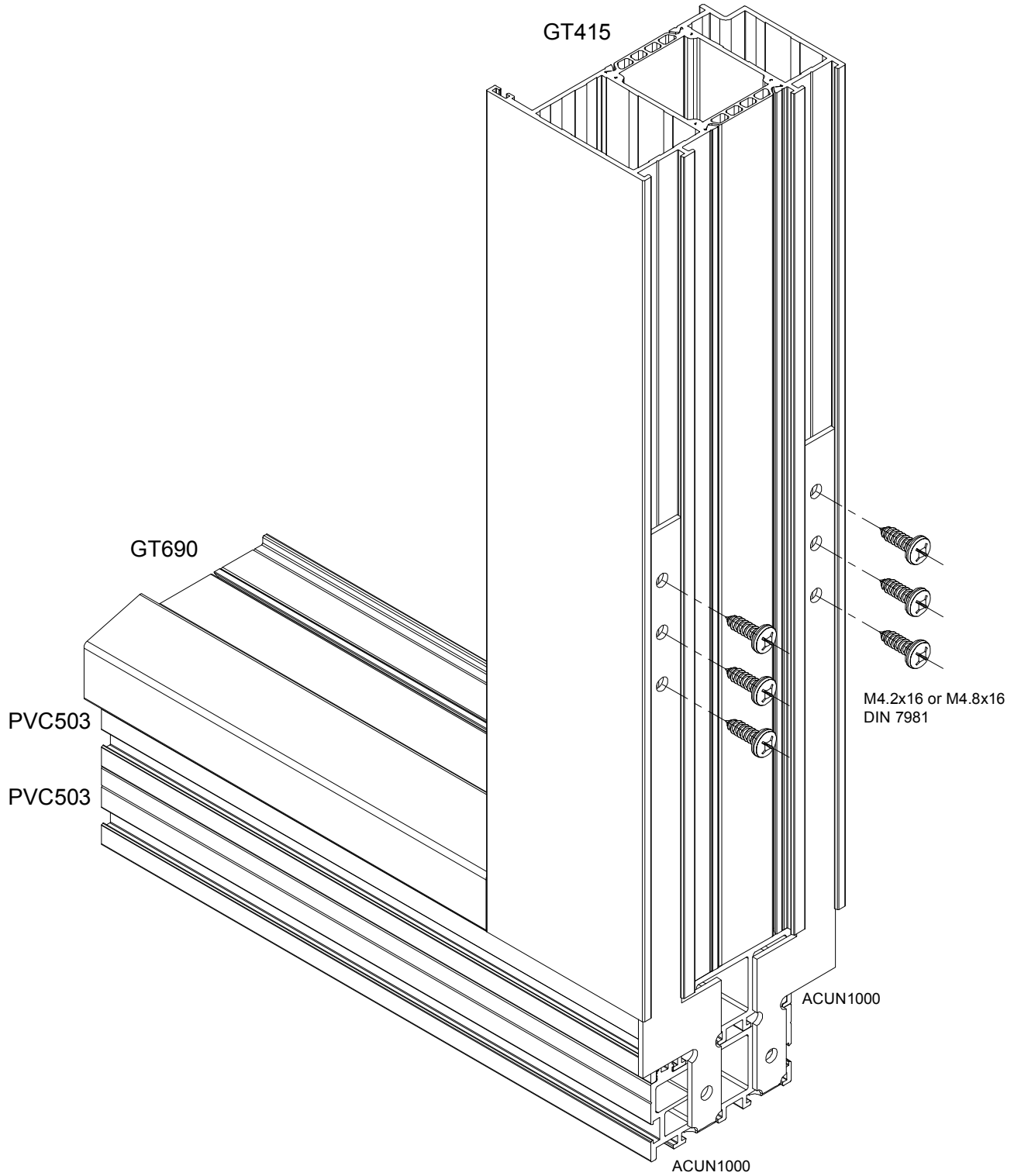

INSTALLATION GUIDELINES

INSTALLATION GUIDELINES

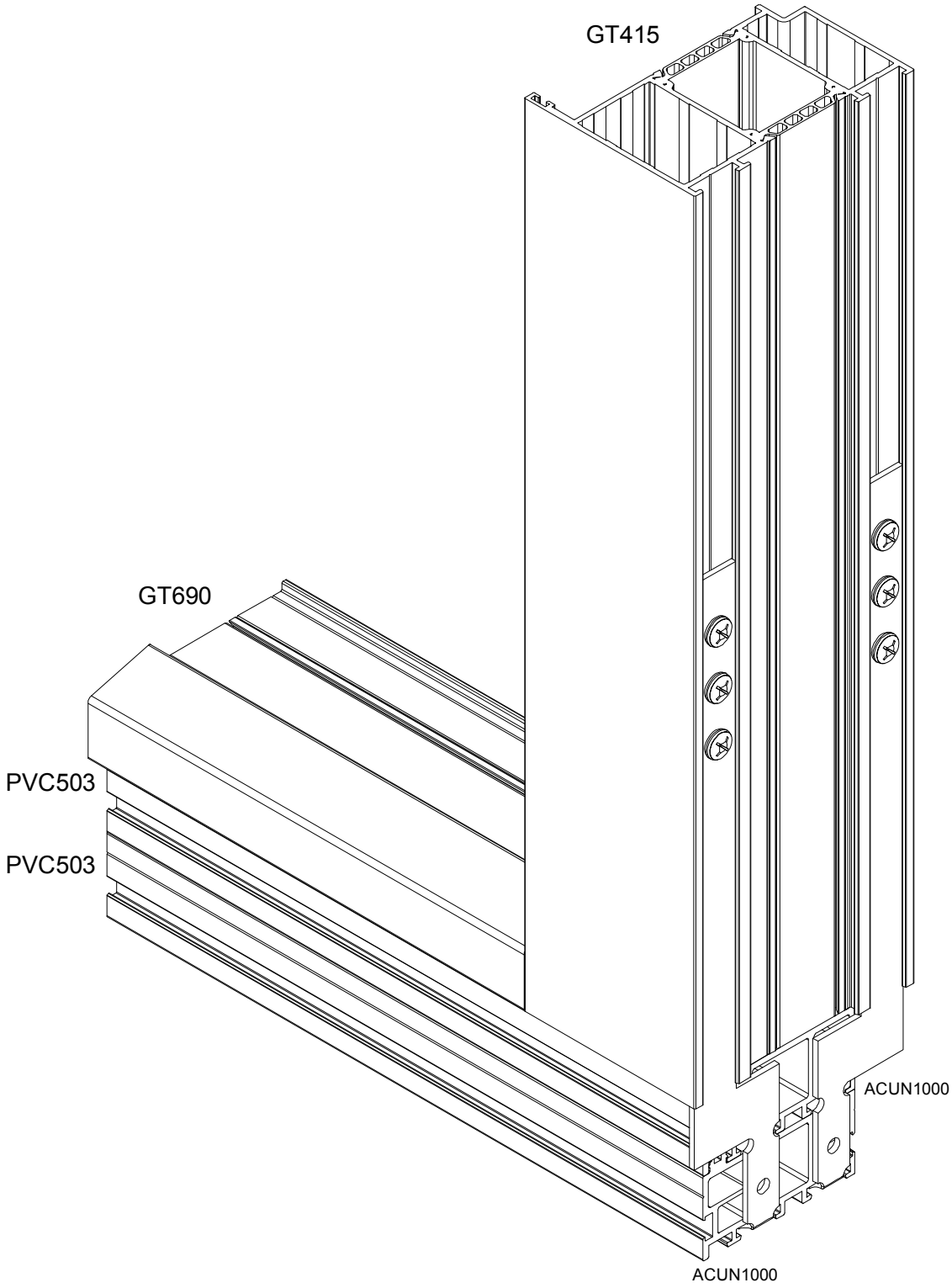

Installation\_14\_06\_2017\_en

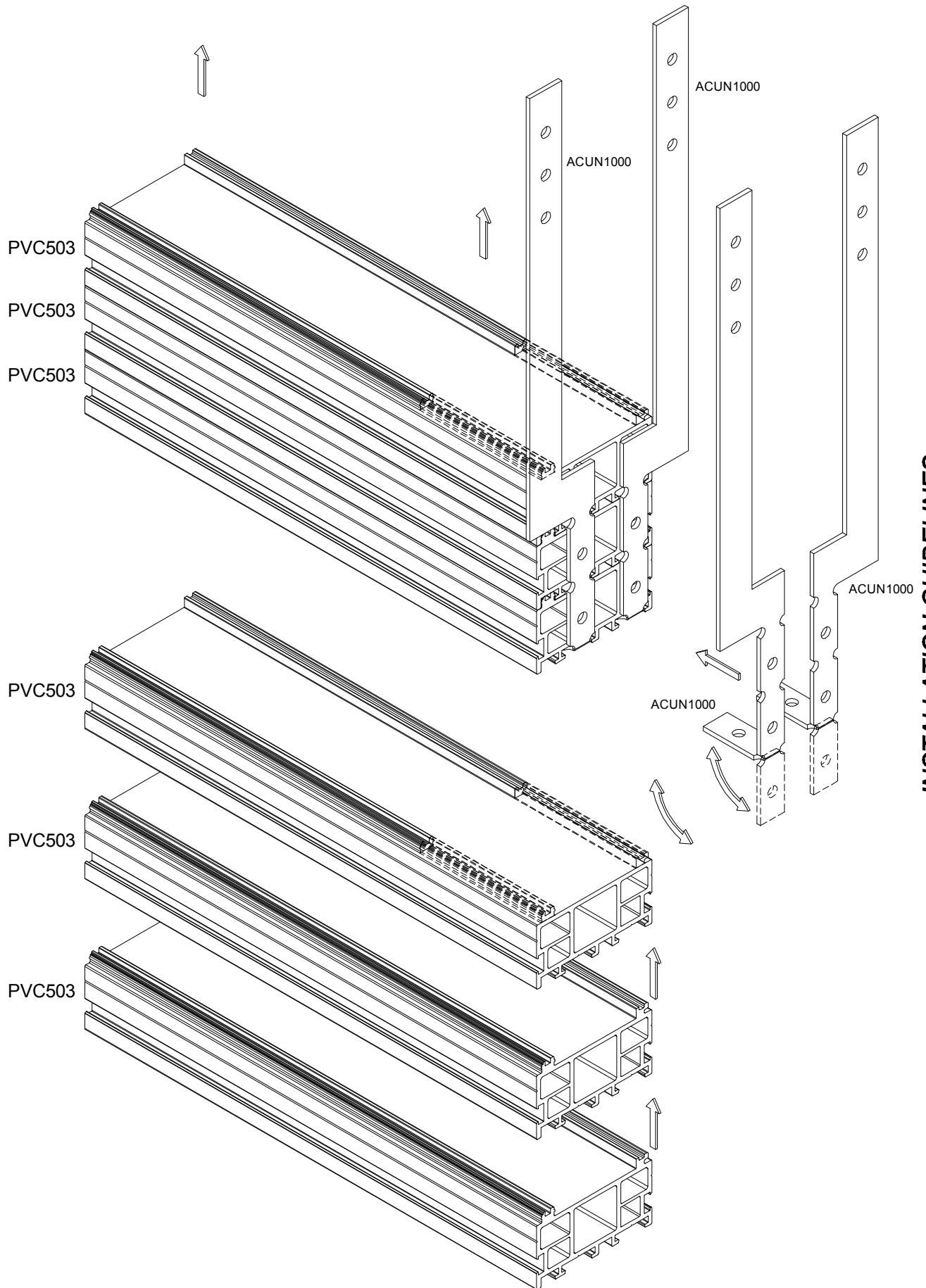

INSTALLATION GUIDELINES

INSTALLATION GUIDELINES

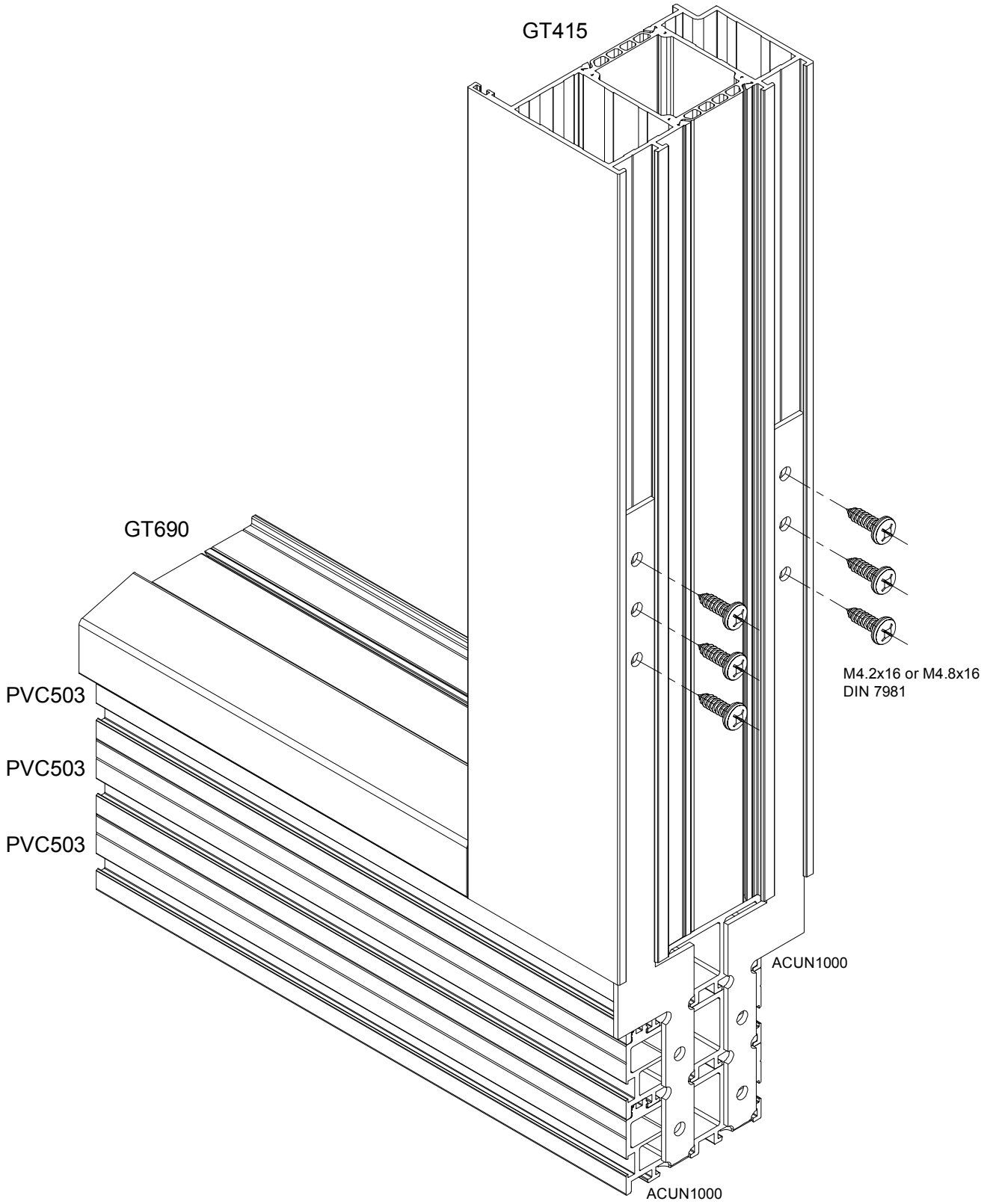

Installation\_14\_06\_2017\_en

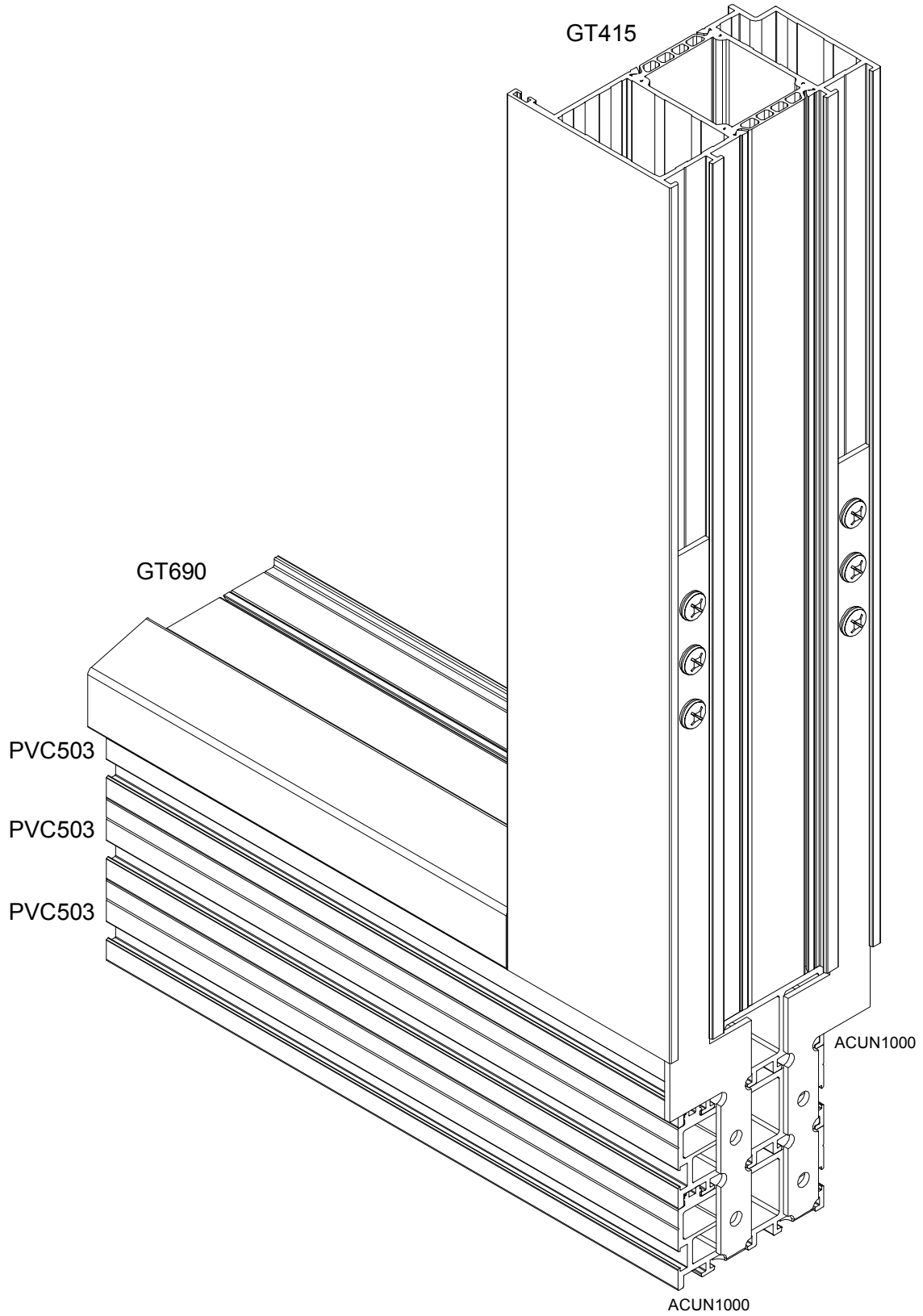

INSTALLATION GUIDELINES

**LOCATION SCHEME OF MOUNTING POINTS  
IN ALUMINIUM FRAMES**

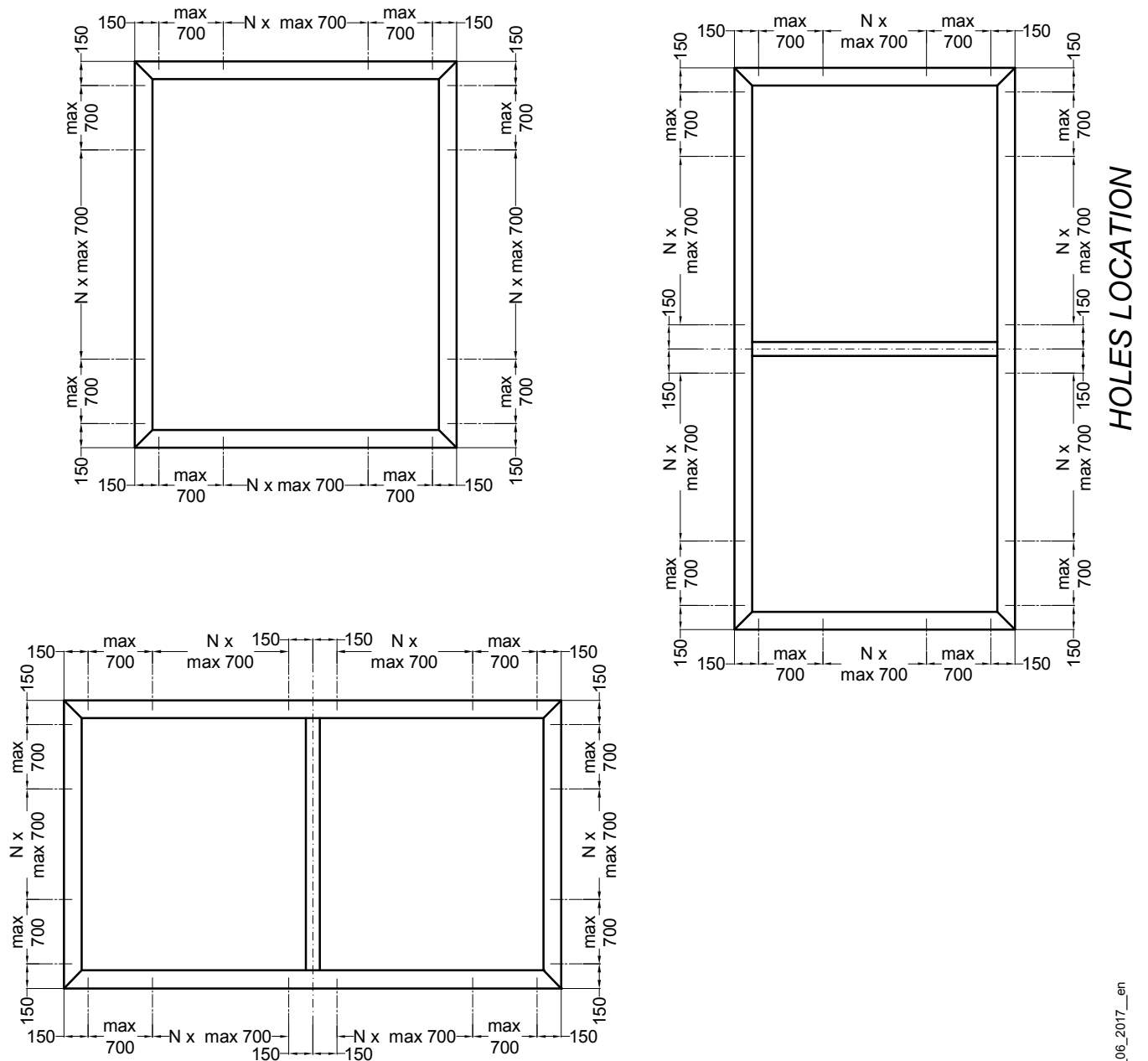

**HOLES LOCATION**

# INSTALLATION ULTRAGLIDE

HOLES LOCATION

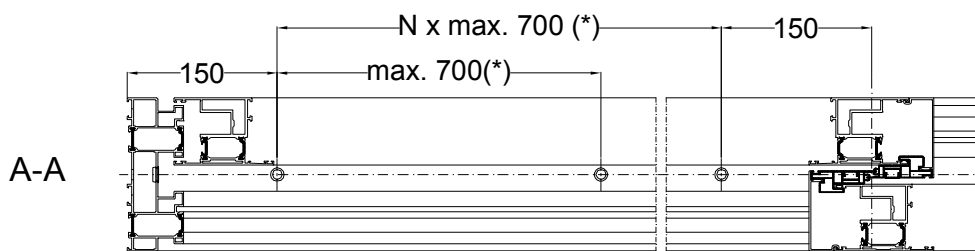

B-B

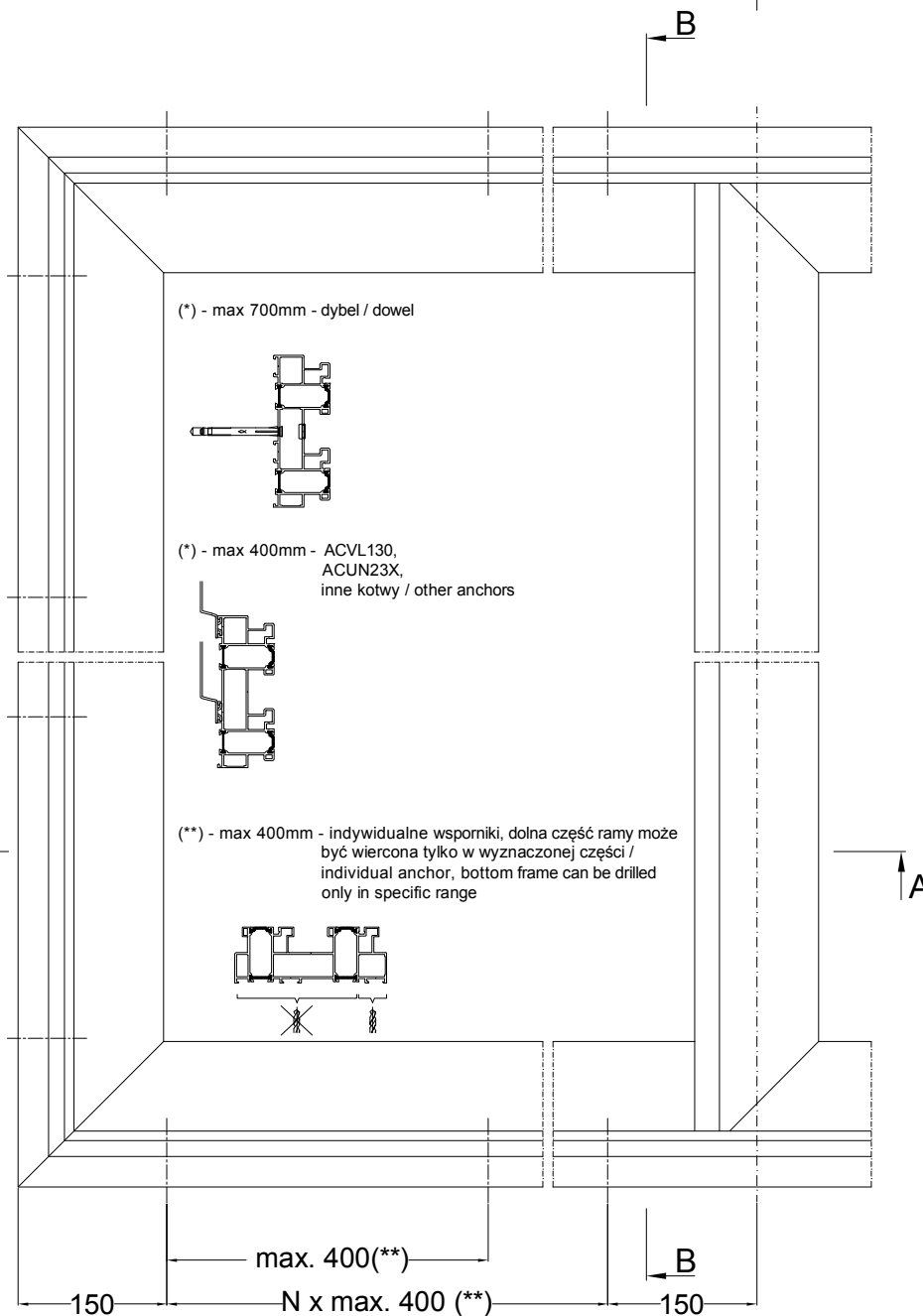
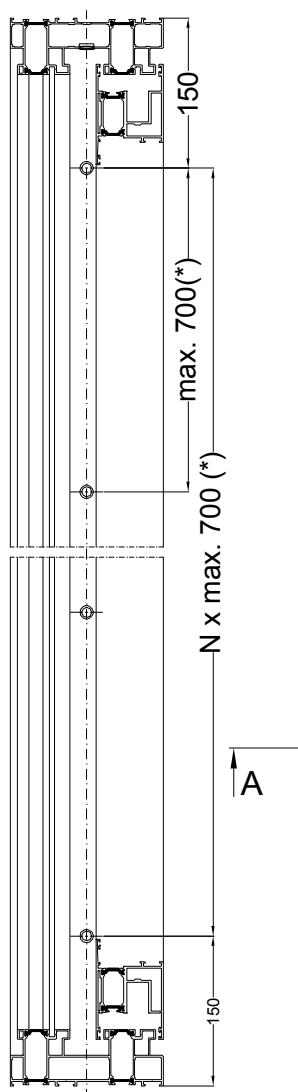

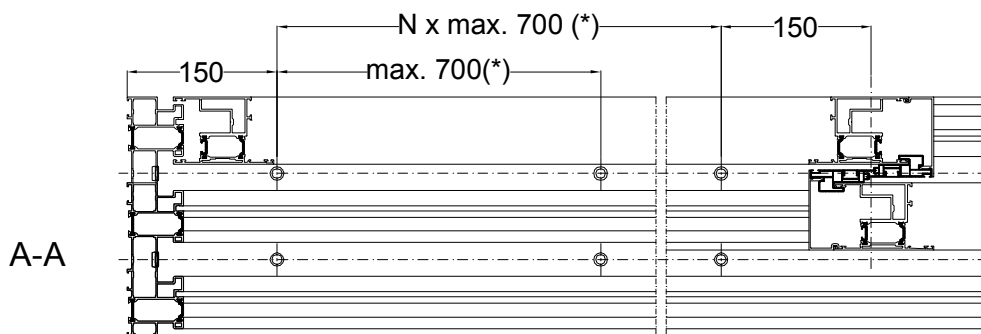

B-B

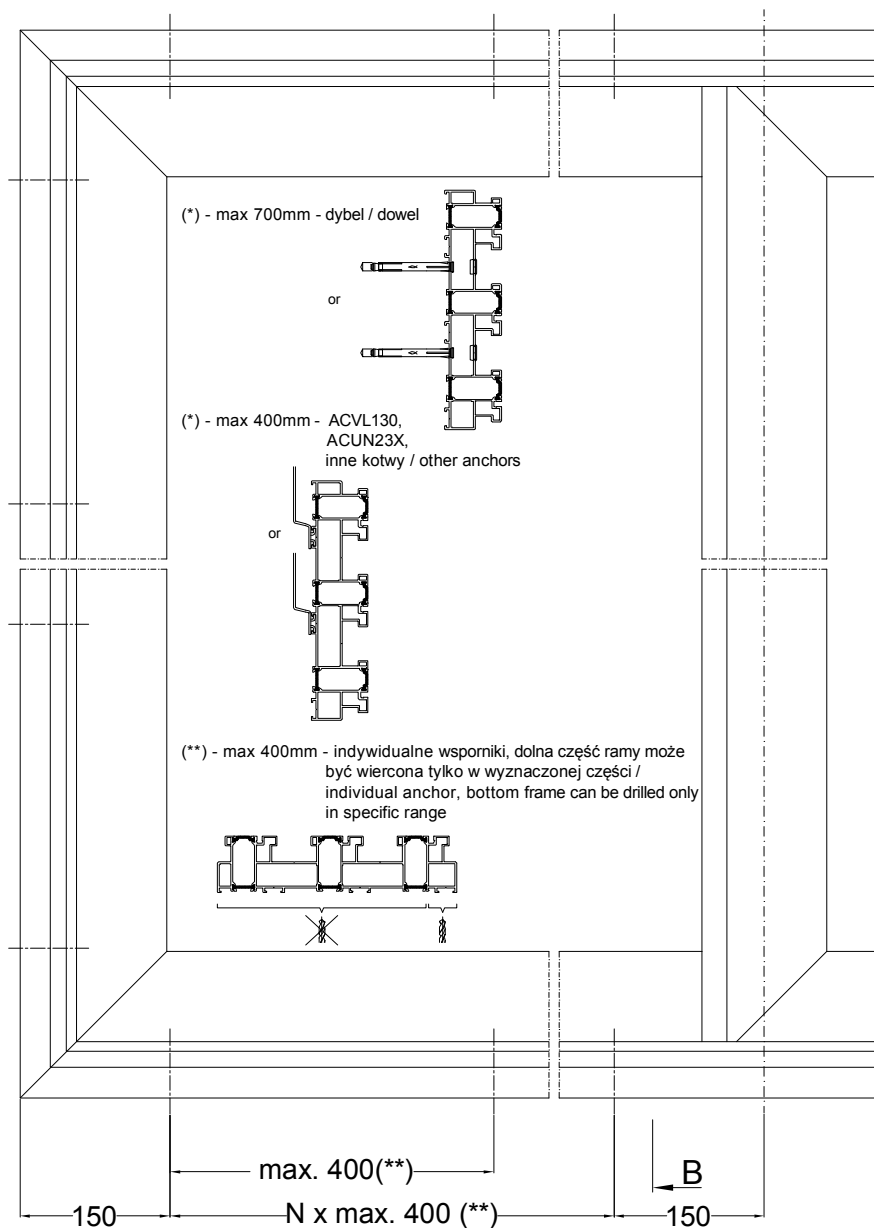
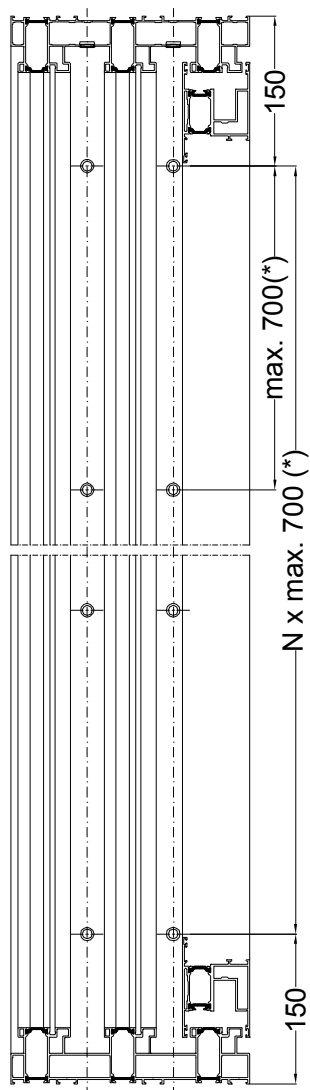

HOLES LOCATION



# INSTALLATION ULTRAGLIDE

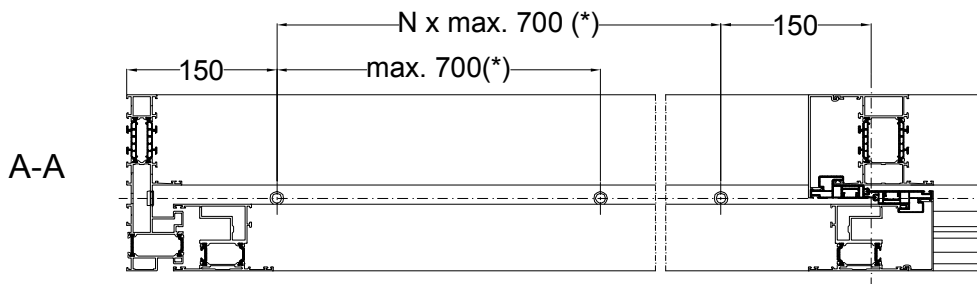

B-B

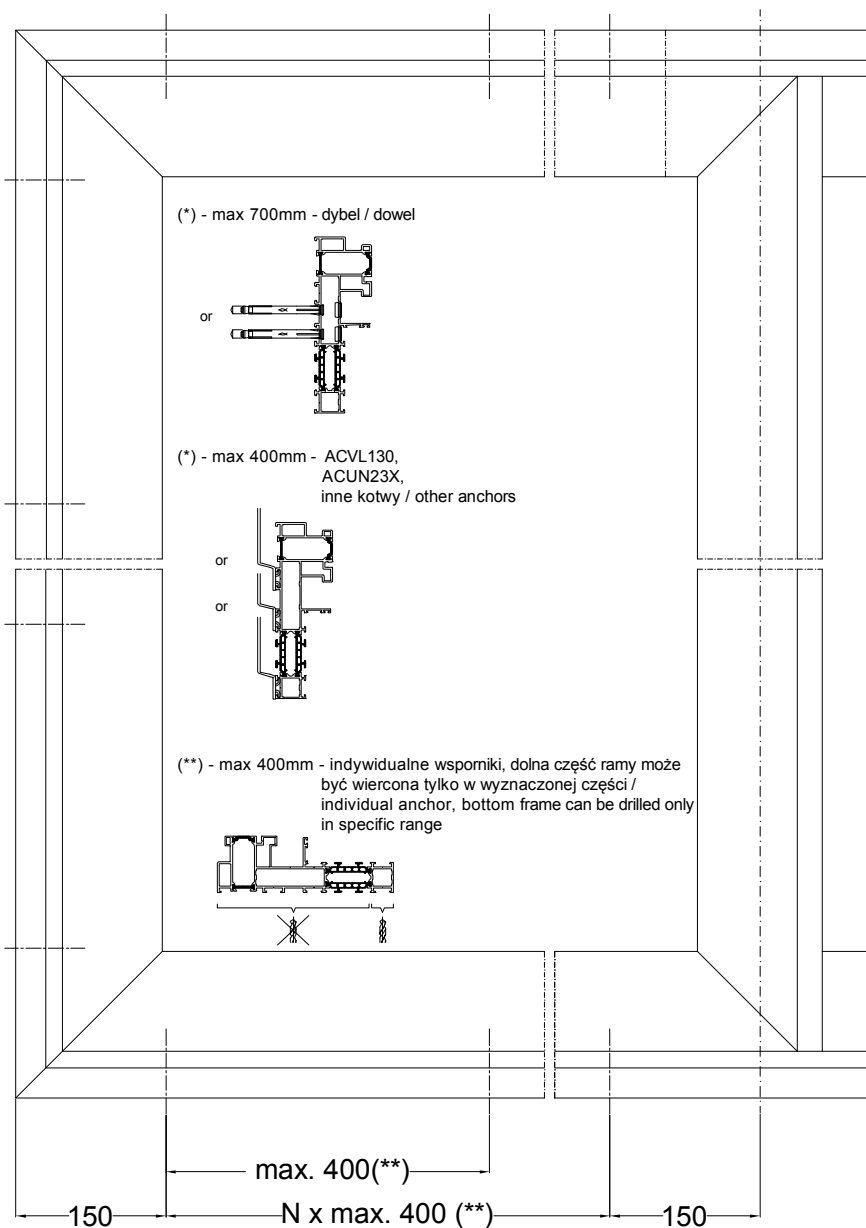
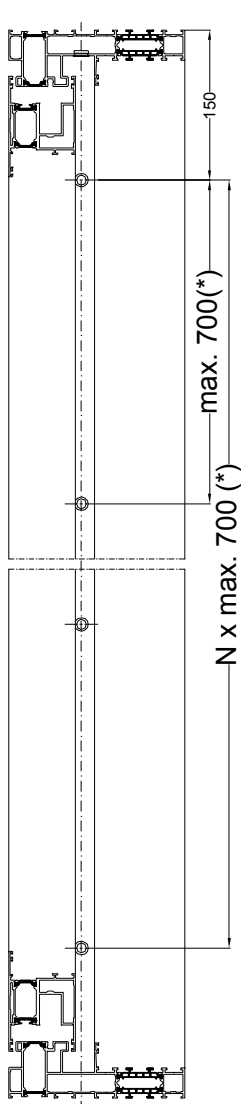

HOLES LOCATION

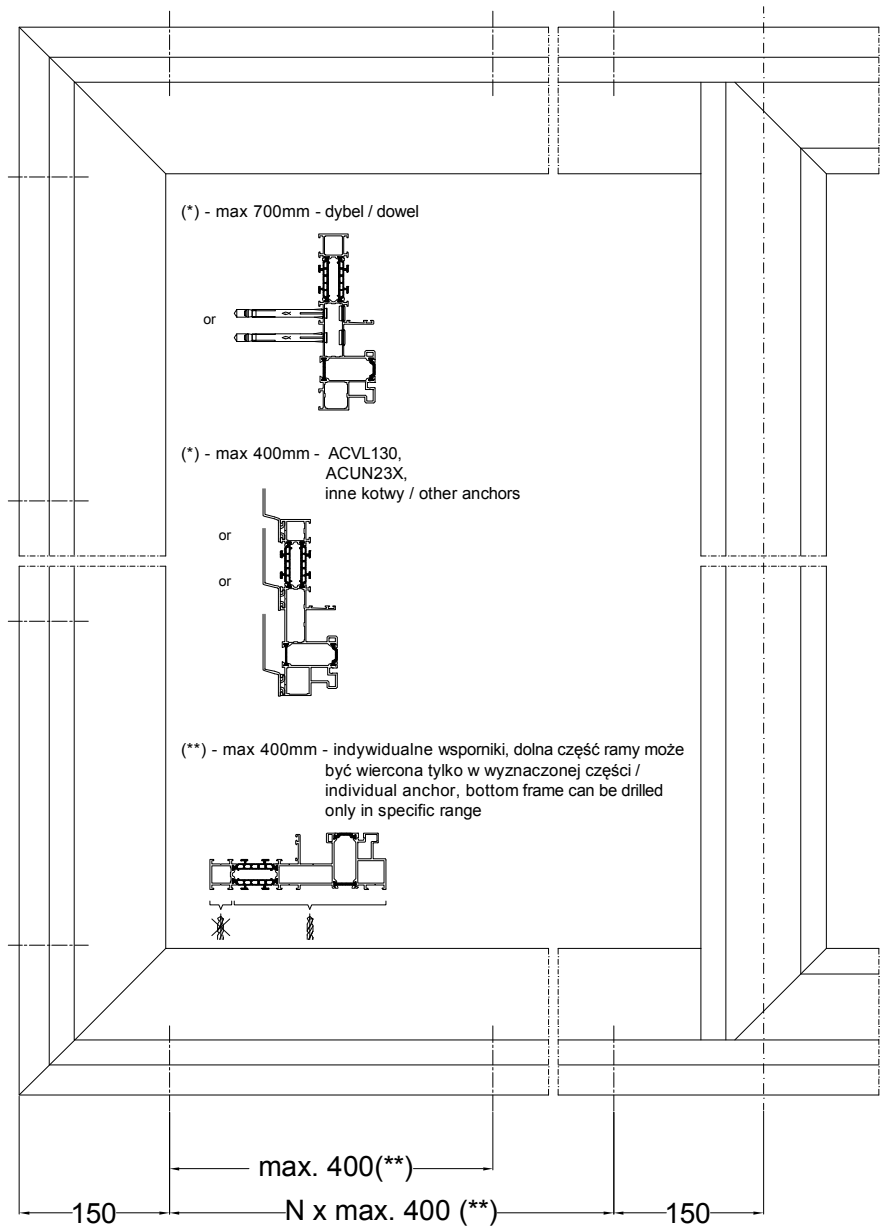
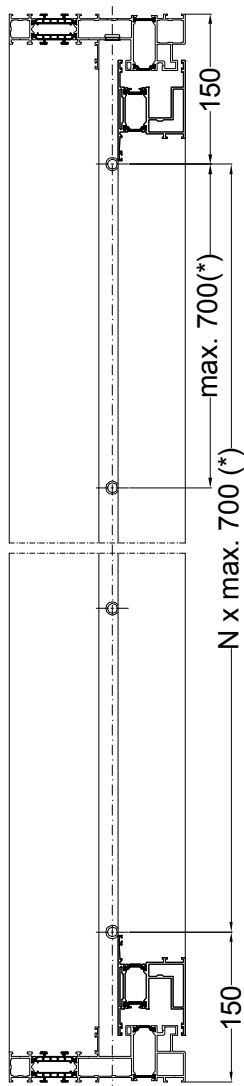
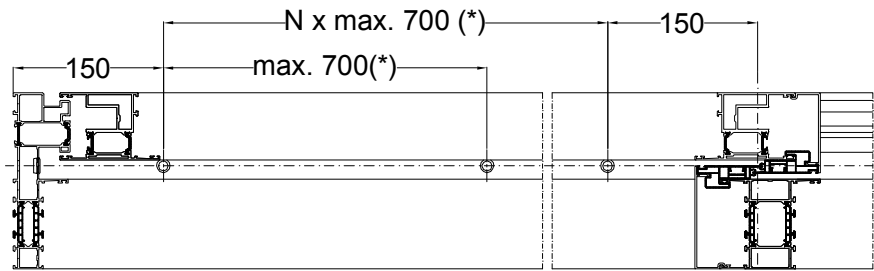

HOLES LOCATION

Depending on the situation in the building use appropriate anchors for MONOBLOCK.

(\*) - : ACMDS208 - ACMDS212,  
ACMDS261 - ACMDS264,  
ACMDS288 - ACMDS291

For each anchors add: ACMDS205 i ACMDS296

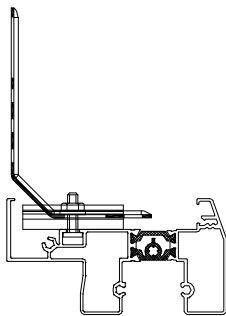

MDS810  
MDS811  
MDS812  
MDS2011  
MDS2013

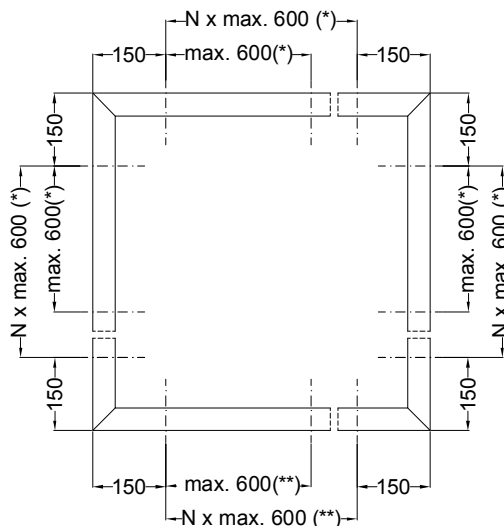

(\*) - : ACMDS208 - ACMDS212,  
ACMDS261 - ACMDS264,  
ACMDS288 - ACMDS291

For each anchors add: ACMDS205 i ACMDS296

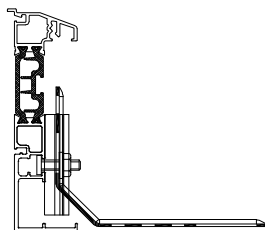

MDS801  
MDS802  
MDS803  
MDS2001  
MDS2003

(\*\*) - : ACMDS202 - ACMDS204,  
ACMDS266 - ACMDS269

For each anchors add: ACMDS206 i ACMDS296

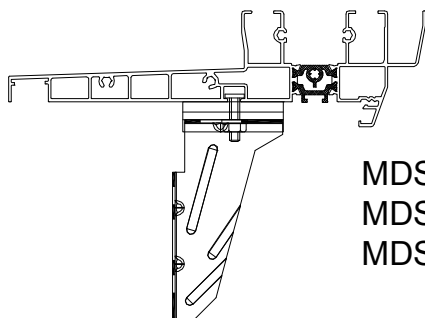

MDS855  
MDS2011  
MDS2013

HOLES LOCATION

MDS010  
MDS011  
MDS110  
MDS111  
...

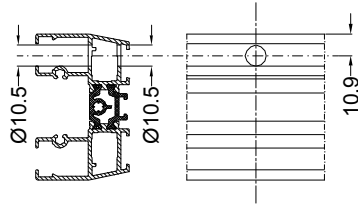

(\*) - max 600mm - dybel / dowel

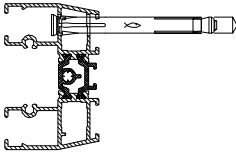

(\*) - max 400mm - ACVL130,  
ACUN23X,  
other anchors

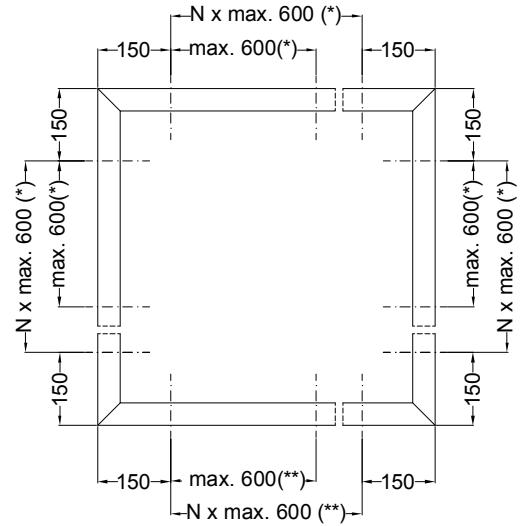
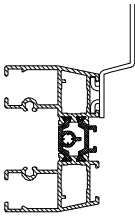

(\*\*) - max 600mm - bottom frame can not be drill

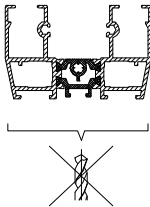

(\*\*) - max 600mm - ancores:  
ACVL130,  
ACUN23X,  
other anchors

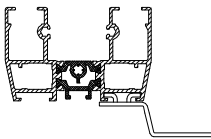

HOLES LOCATION

# INSTALLATION MDS

- MDS012
- MDS013
- MDS014
- MDS015
- MDS212
- MDS213
- ...

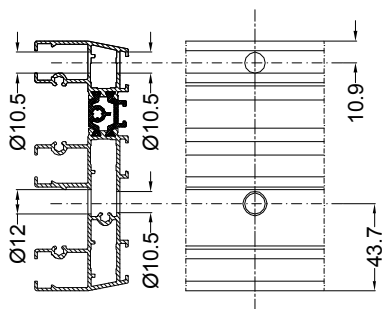

(\*) - max 600mm - dowel

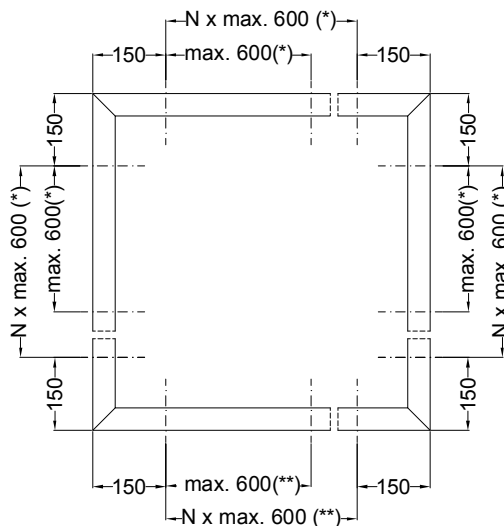
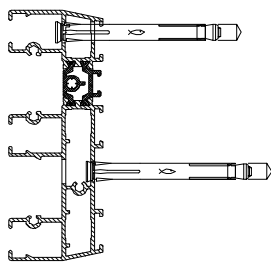

(\*) - max 400mm - ACVL130,  
ACUN23X,  
other anchors

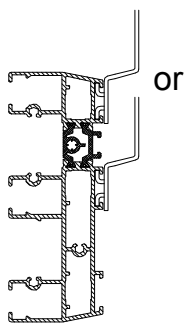

(\*\*) - max 600mm - bottom frame can not be drill

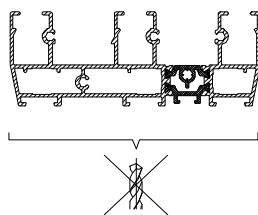

(\*\*) - max 600mm - kotwy: ACVL130, ACUN23X, other anchors

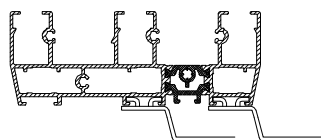

HOLES LOCATION

Depending on the situation in the building use appropriate anchors for MONOBLOCK.

(\*) - : ACMDS208 - ACMDS212,  
ACMDS261 - ACMDS264,  
ACMDS288 - ACMDS291

For each anchors add: ACMDS205 i ACMDS296

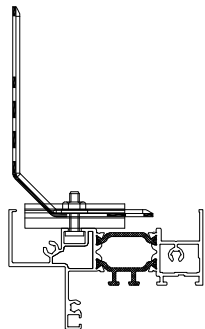

EF811, EF814,  
EF821, EF831,

EF851, EF854,  
EF861, EF871

(\*) - : ACMDS208 - ACMDS212,  
ACMDS261 - ACMDS264,  
ACMDS288 - ACMDS291

For each anchors add: ACMDS205 i ACMDS296

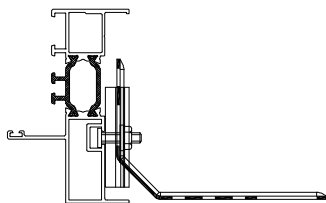

EF810, EF820, EF830,

EF850, EF860, EF870

(\*\*) - : ACMDS202 - ACMDS204,  
ACMDS266 - ACMDS269

For each anchors add: ACMDS206 i ACMDS296

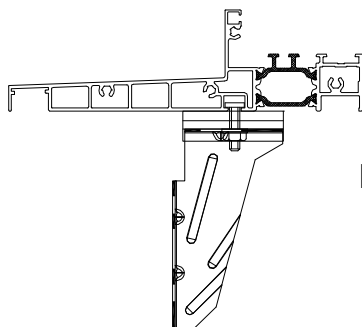

EF813, EF853

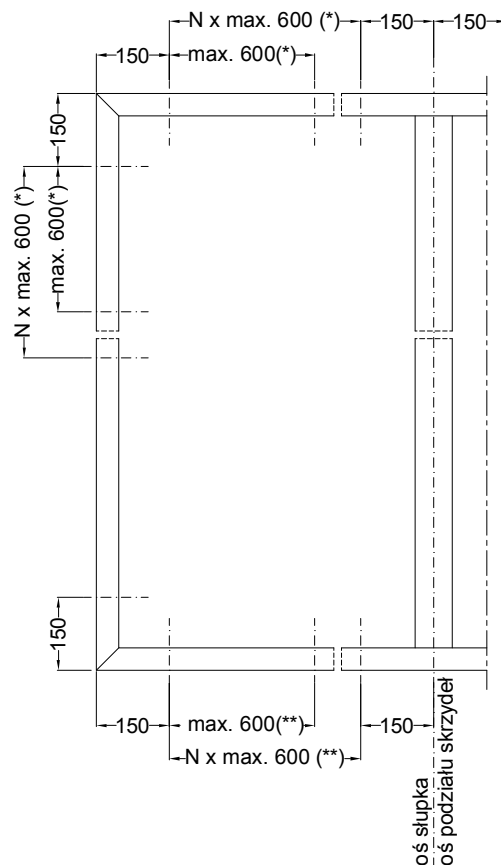

HOLES LOCATION

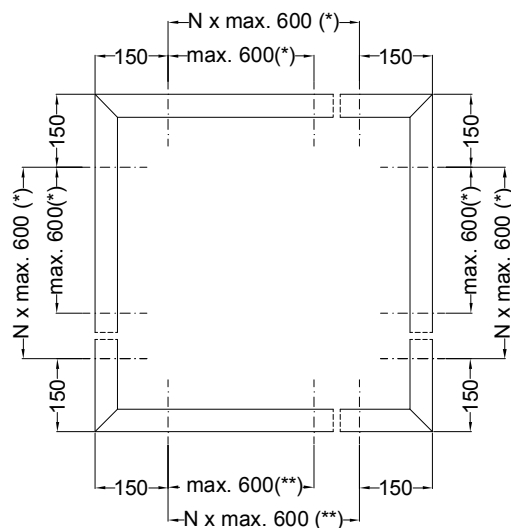

# INSTALLATION STAR

GT010  
GT011  
GT012  
GT013  
GT015

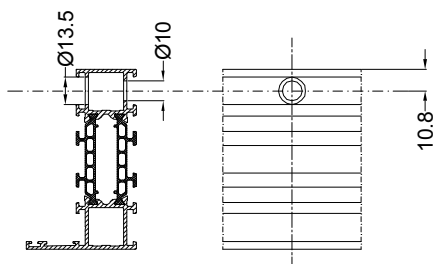

(\*) - max 700mm - dowel

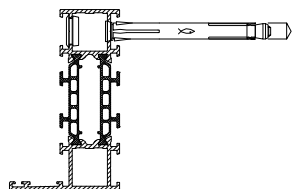

(\*) - max 400mm - ACVL130,  
ACUN23X,  
other anchores

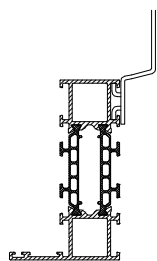

(\*\*) - max 400mm - individual anchor, bottom  
frame can be drilled only in  
specific range

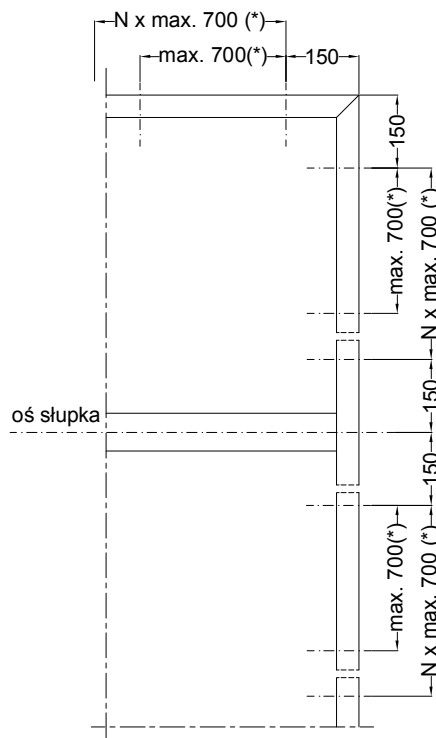
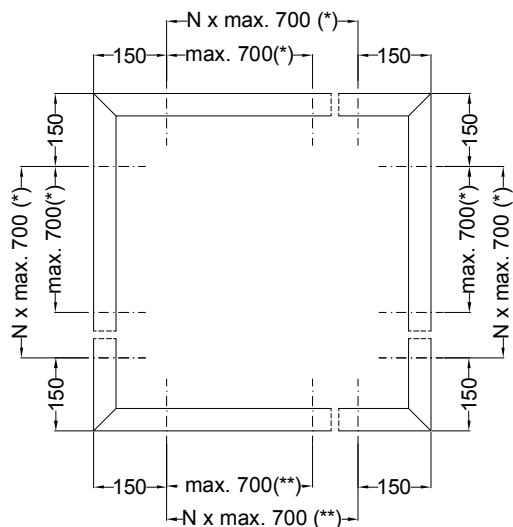
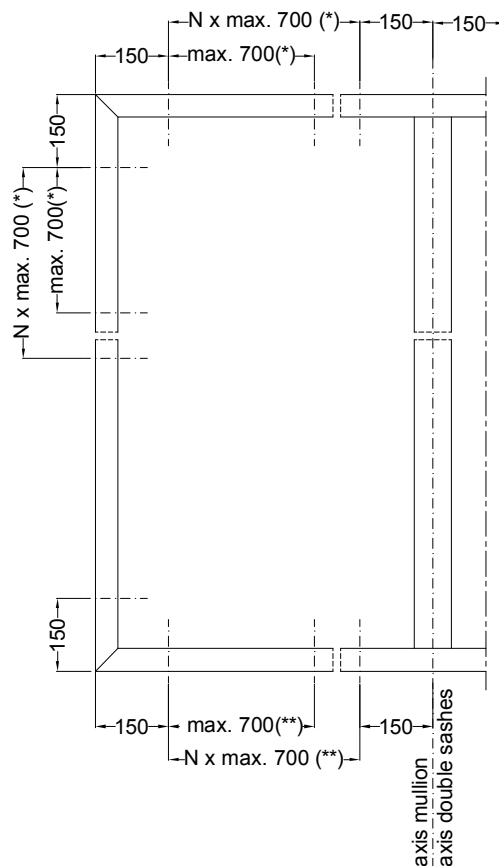
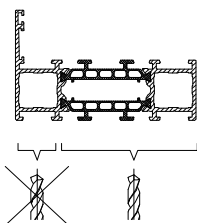

HOLE LOCATION

SP010  
SP011  
SP012  
...

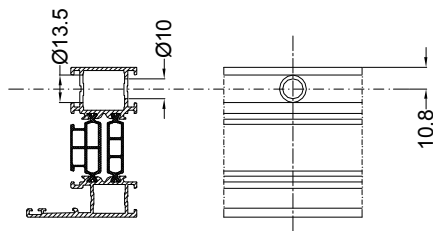

(\*) - max 700mm - dowel

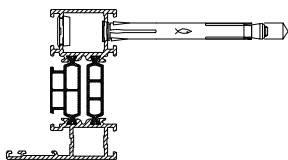

(\*) - max 400mm - ACVL130,  
ACUN23X,  
other anchors

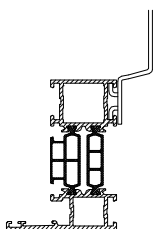

(\*\*) - max 400mm - individual anchor,  
bottom frame can be drilled  
only in specific range

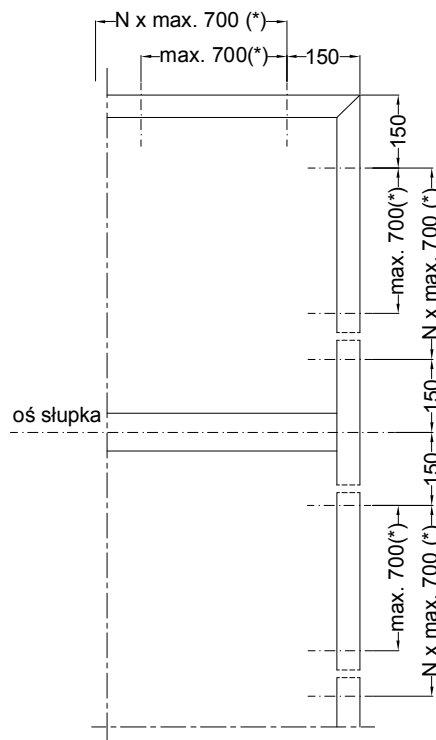
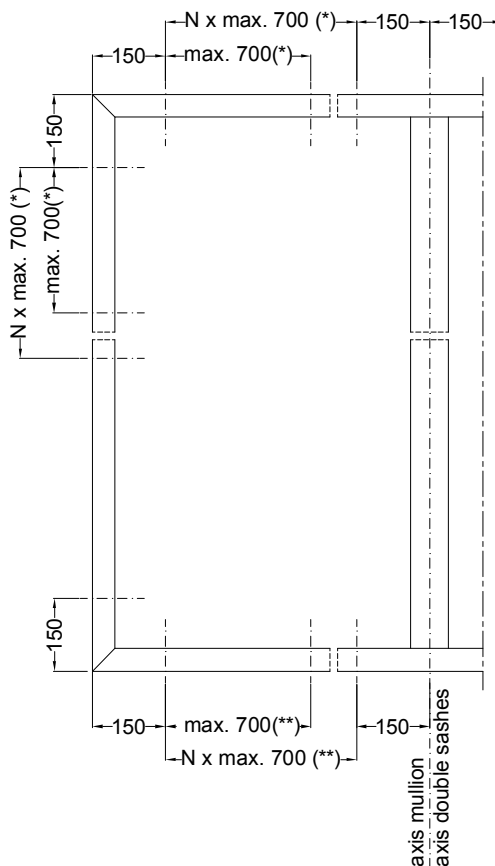
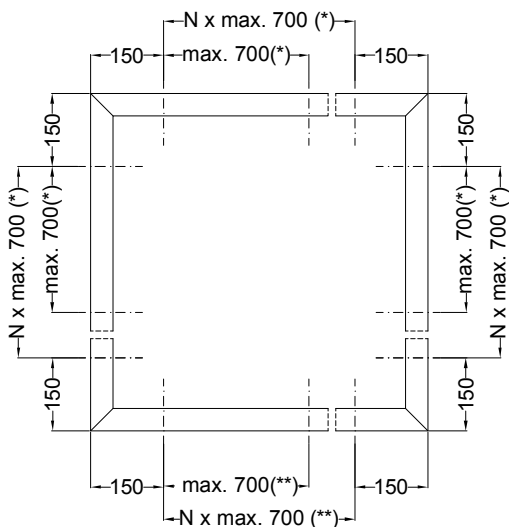
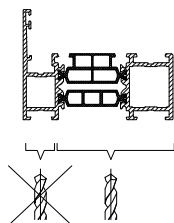

HOLES LOCATION



# INSTALLATION IMPERIAL

IP010  
IP011  
IP012  
...

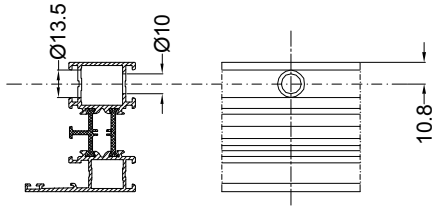

(\*) - max 700mm - dowel

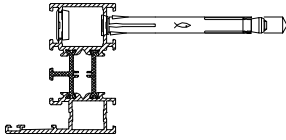

(\*) - max 400mm - ACVL130,  
ACUN23X,  
other anchors

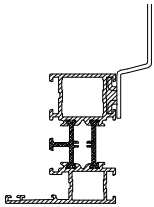

(\*\*) - max 400mm - individual anchor,  
bottom frame can be drilled  
only in specific range

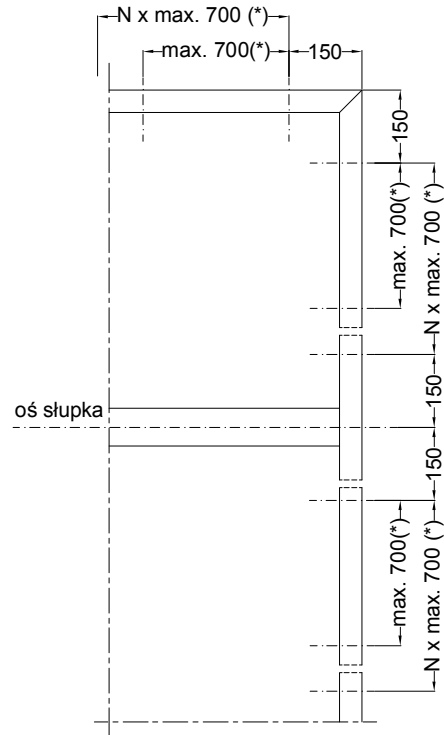
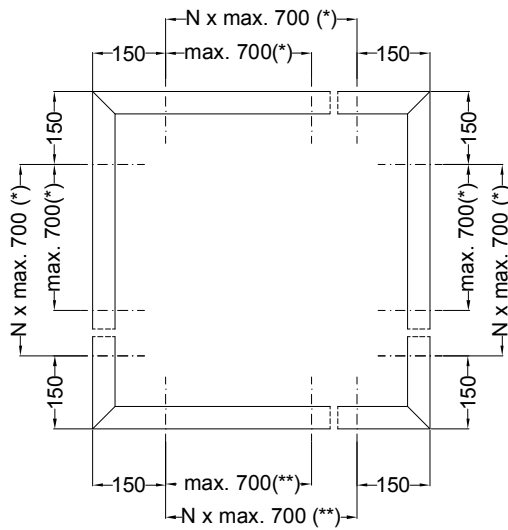
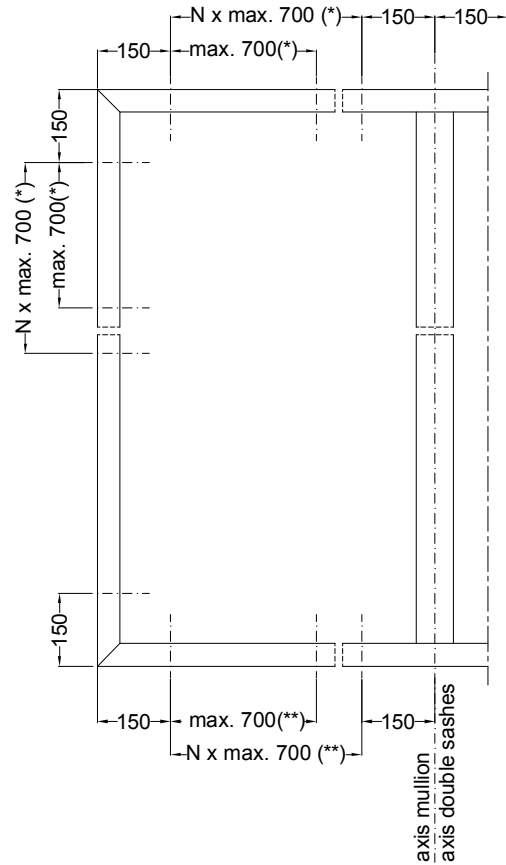
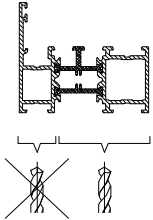

HOLES LOCATION

EF010  
EF011  
EF012  
...  
EF213  
EF214  
EF217

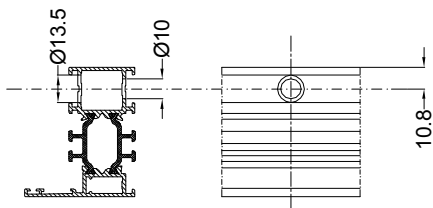

(\*) - max 700mm - dowel

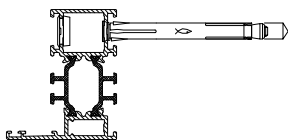

(\*) - max 400mm - ACVL130,  
ACUN23X,  
other anchors

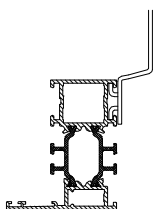

(\*\*) - max 400mm - individual anchor,  
bottom frame can be drilled  
only in specific range

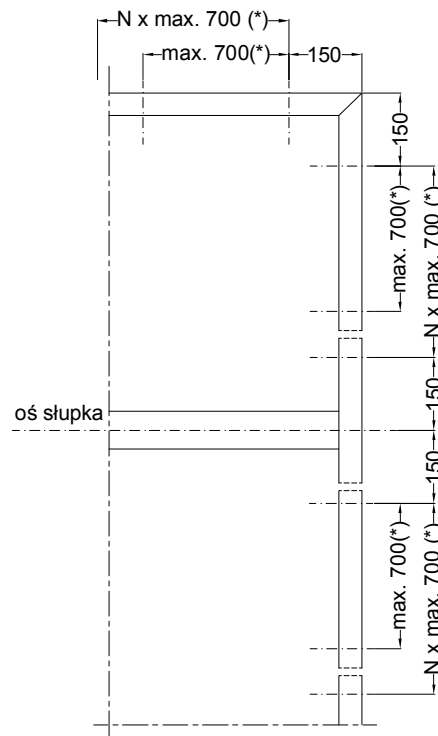
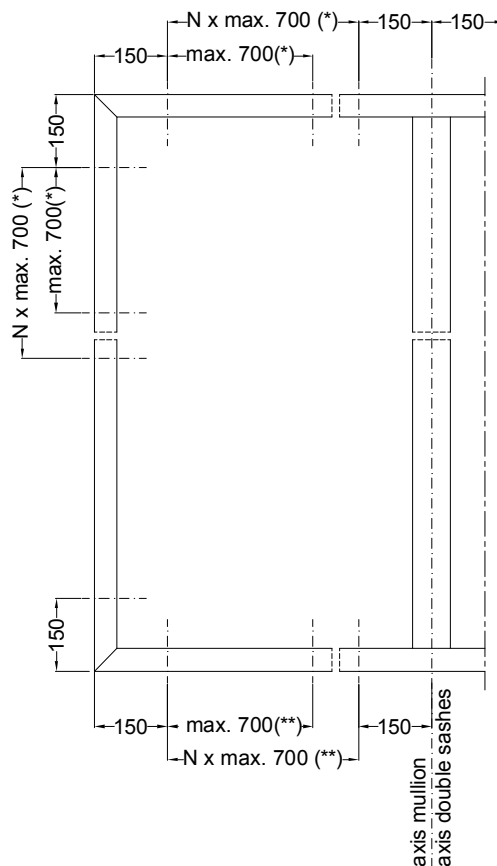
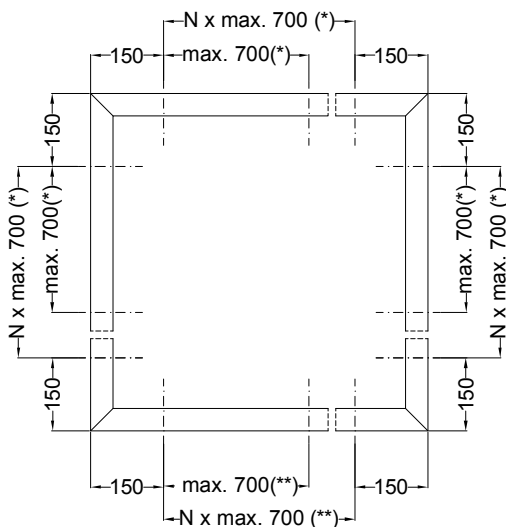
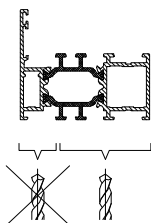

HOLES LOCATION

# INSTALLATION IP, SP, EF

**aliplast**  
ALUMINIUM SYSTEMS

LOCATION OF MOUNTING HOLES IN FRAMES

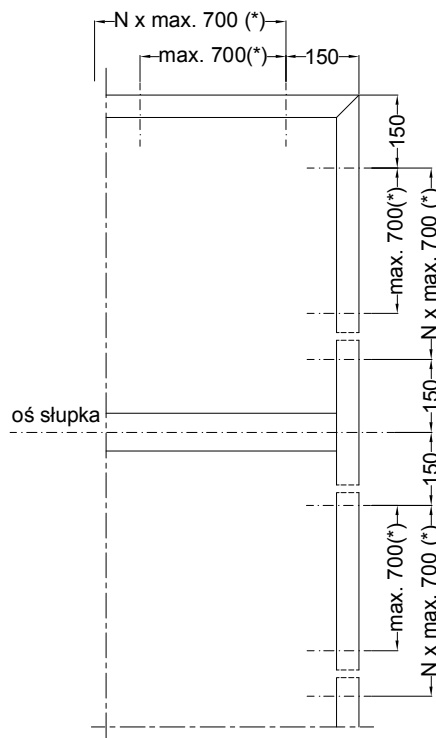
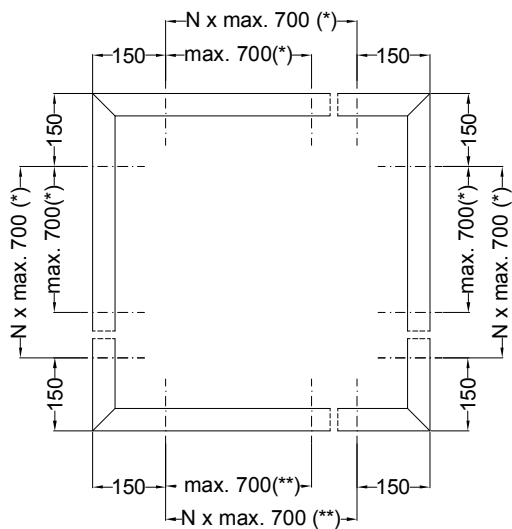
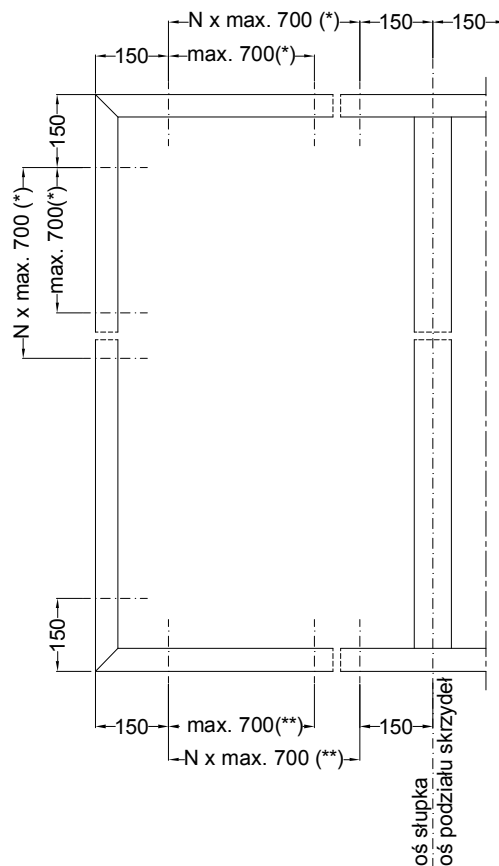
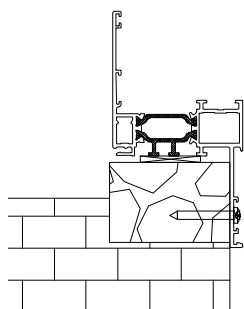
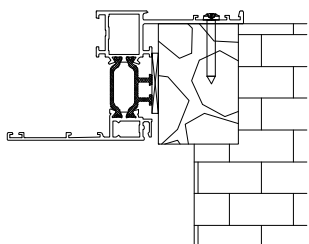
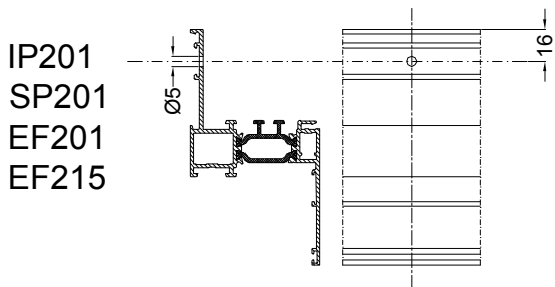

HOLES LOCATION

installation\_14\_06\_2017\_en

MO-F-014

16/6/2017



**GT415**

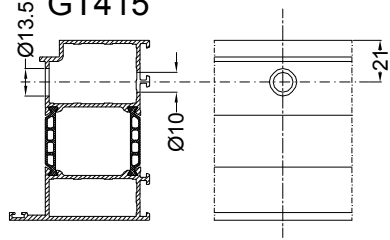

**GT414**

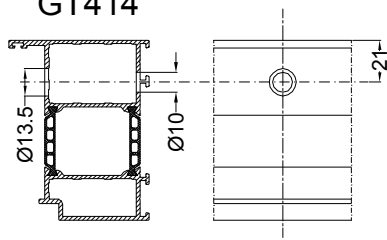

**SP815**

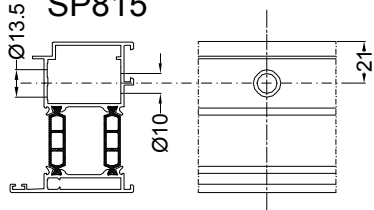

**SP814**

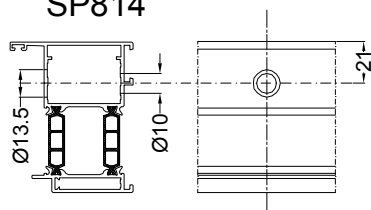

**IP815**

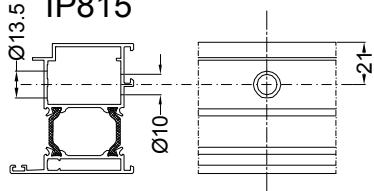

**IP814**

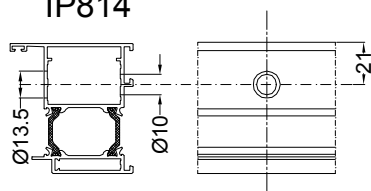

(\*) - max 700mm - dybel /  
 dowel

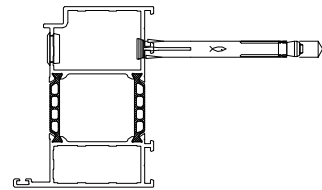

(\*) - max 400mm - ACVL130,  
 ACUN23X  
 and other anchors -  
 only on handle side

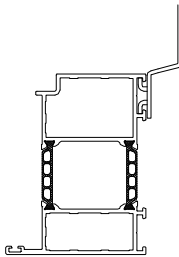

(\*\*) - max 700mm - individual anchor,  
 sill can not be  
 drilled

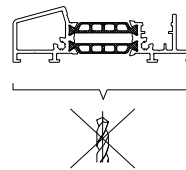

HOLES LOCATION

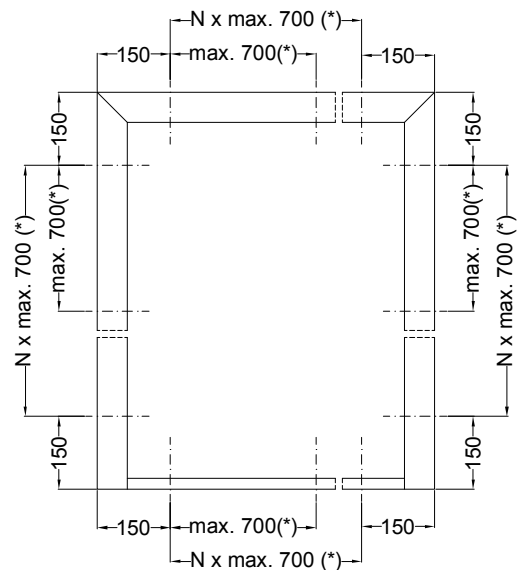
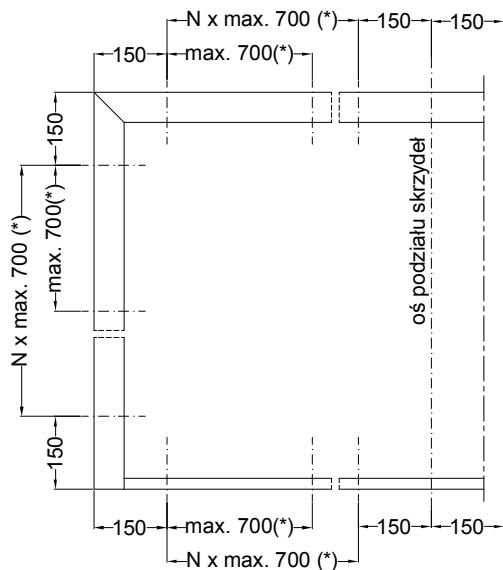

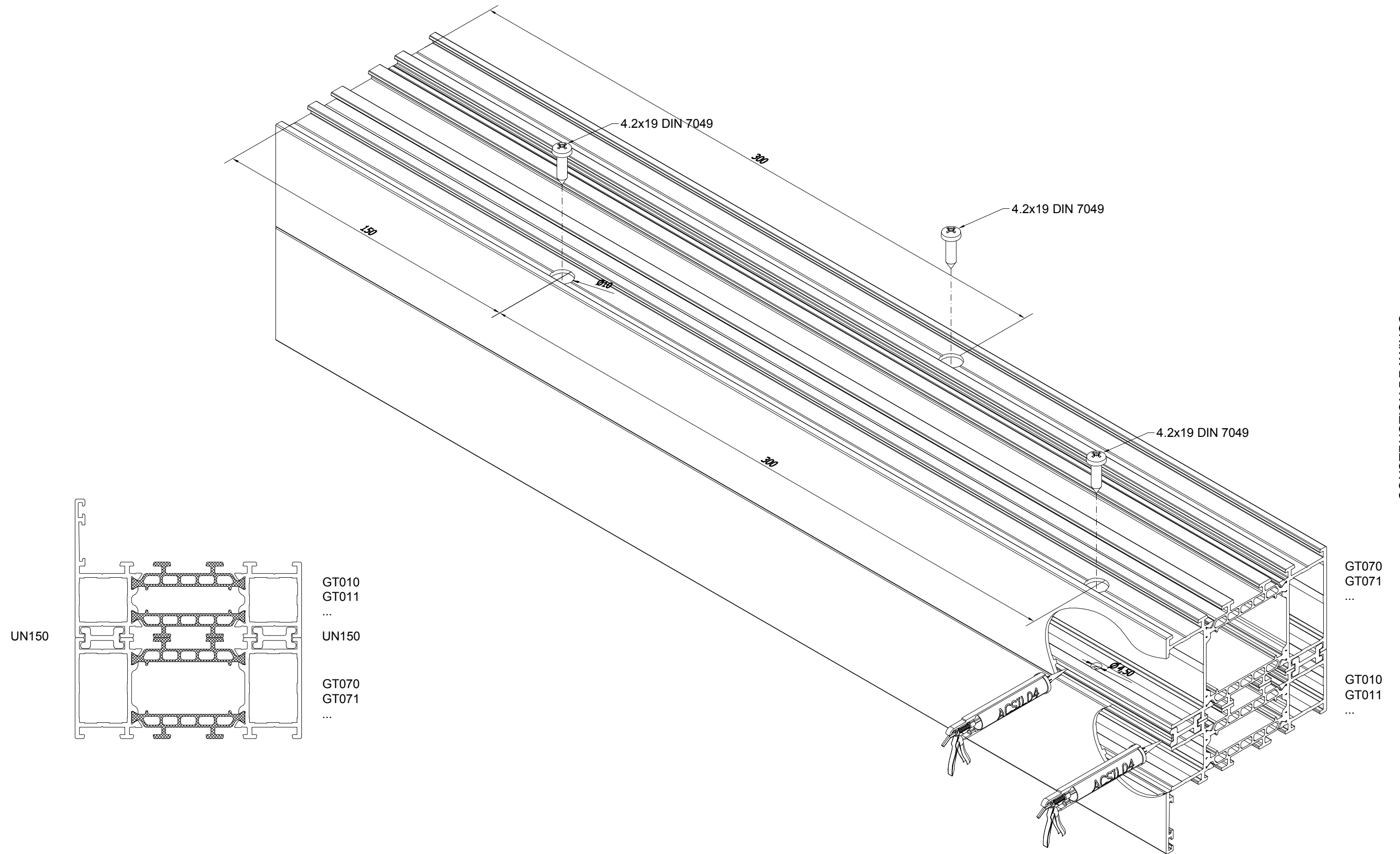

CONSTRUCTION DRAWINGS

installation\_14\_06\_20

# INSTALLATION STAR

CONSTRUCTION DRAWINGS

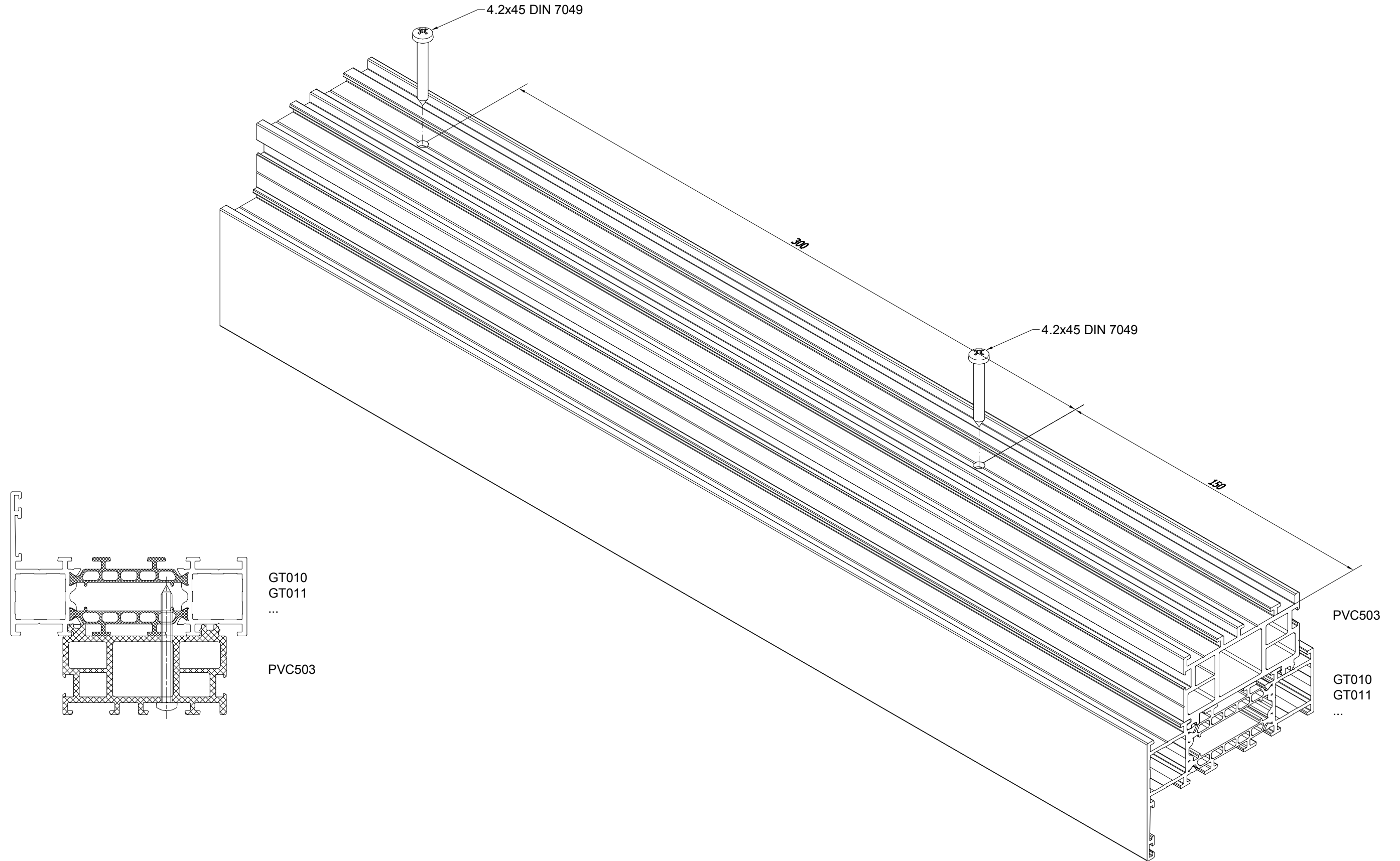

installation\_14\_06\_2017\_\_en

MO-F-018

16/6/2017

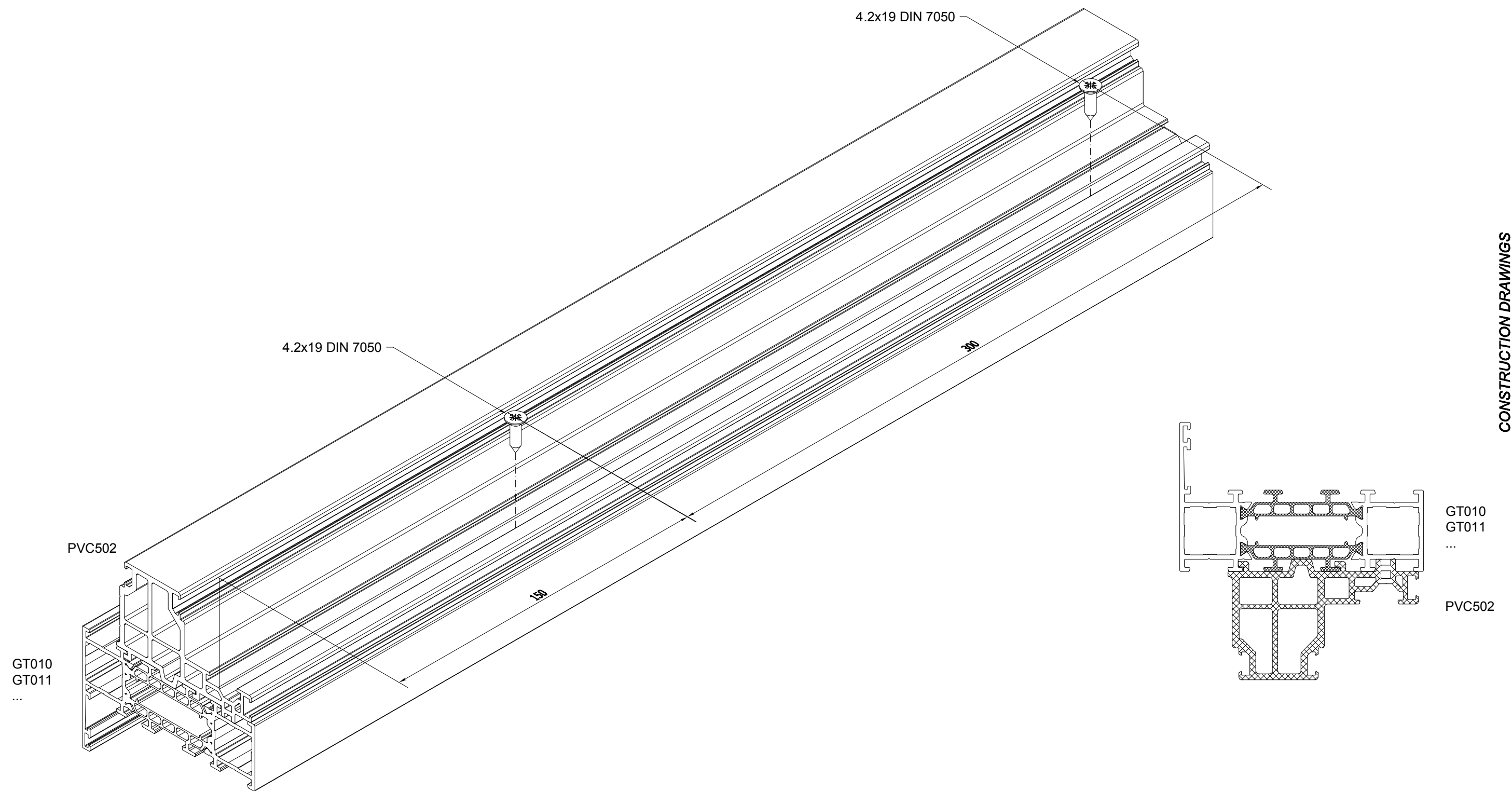

# INSTALLATION STAR

CONSTRUCTION DRAWINGS

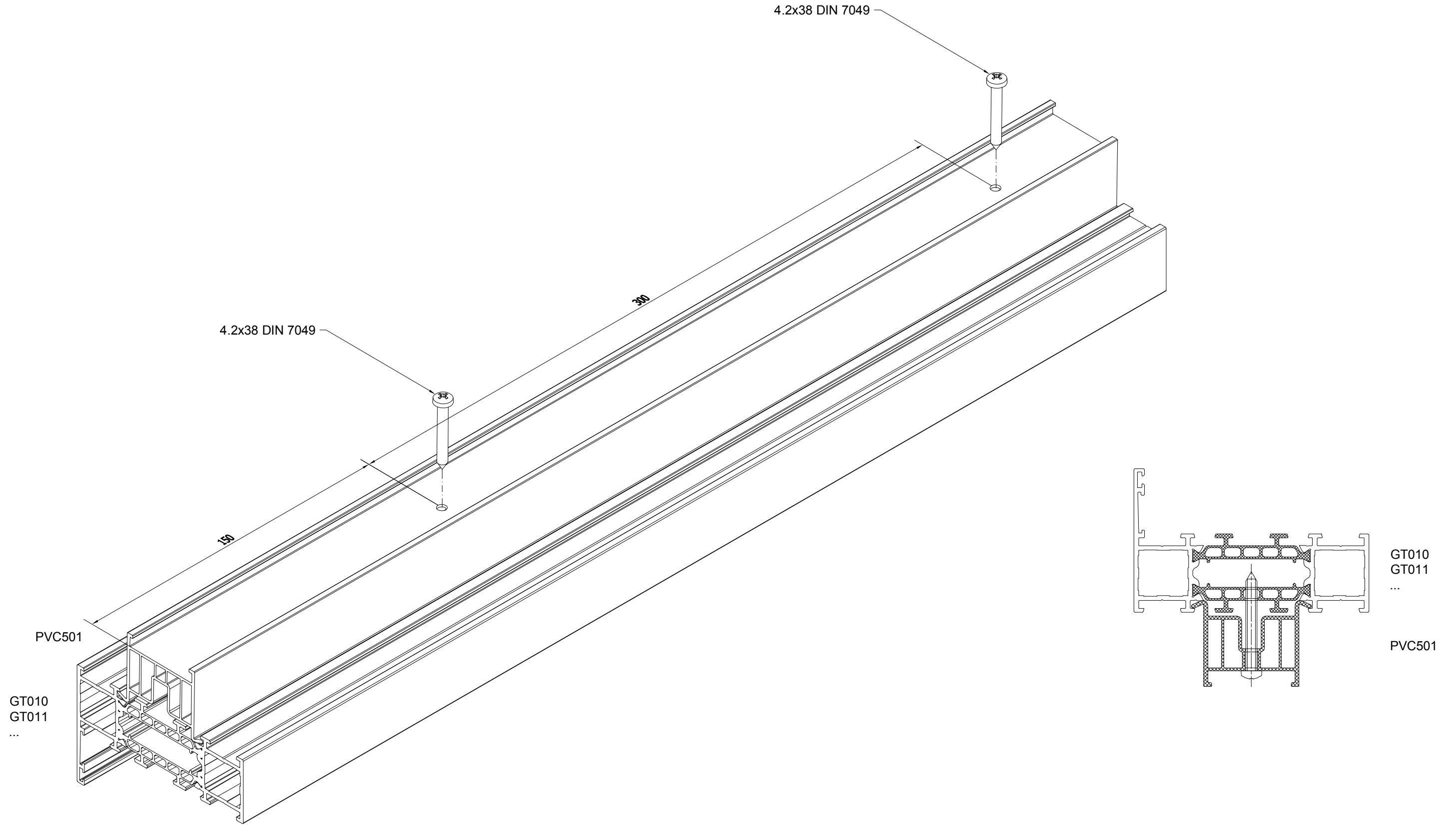

installation\_14\_06\_2017\_\_en

MO-F-020

16/6/2017



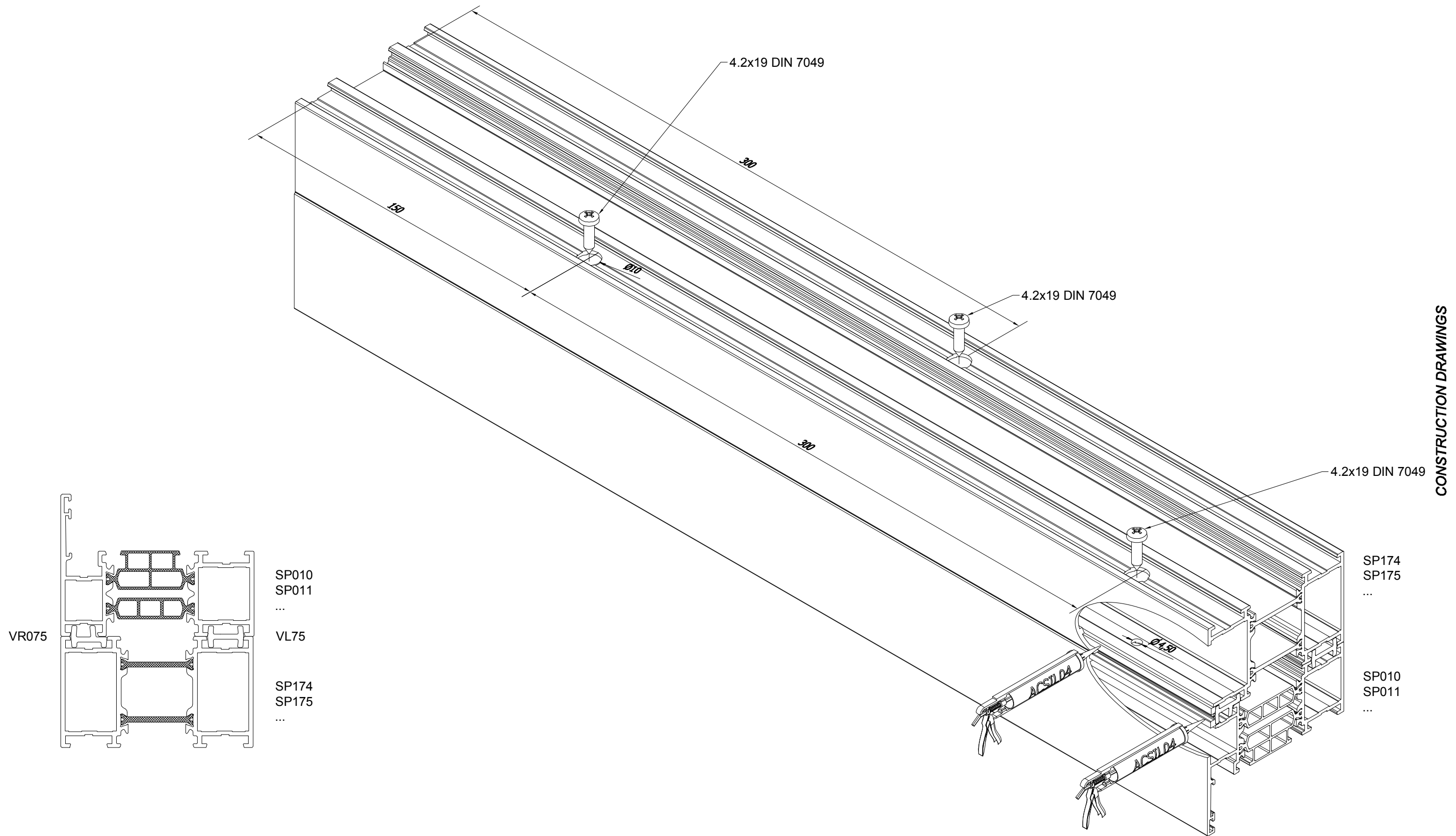

# INSTALLATION SP

CONSTRUCTION DRAWINGS

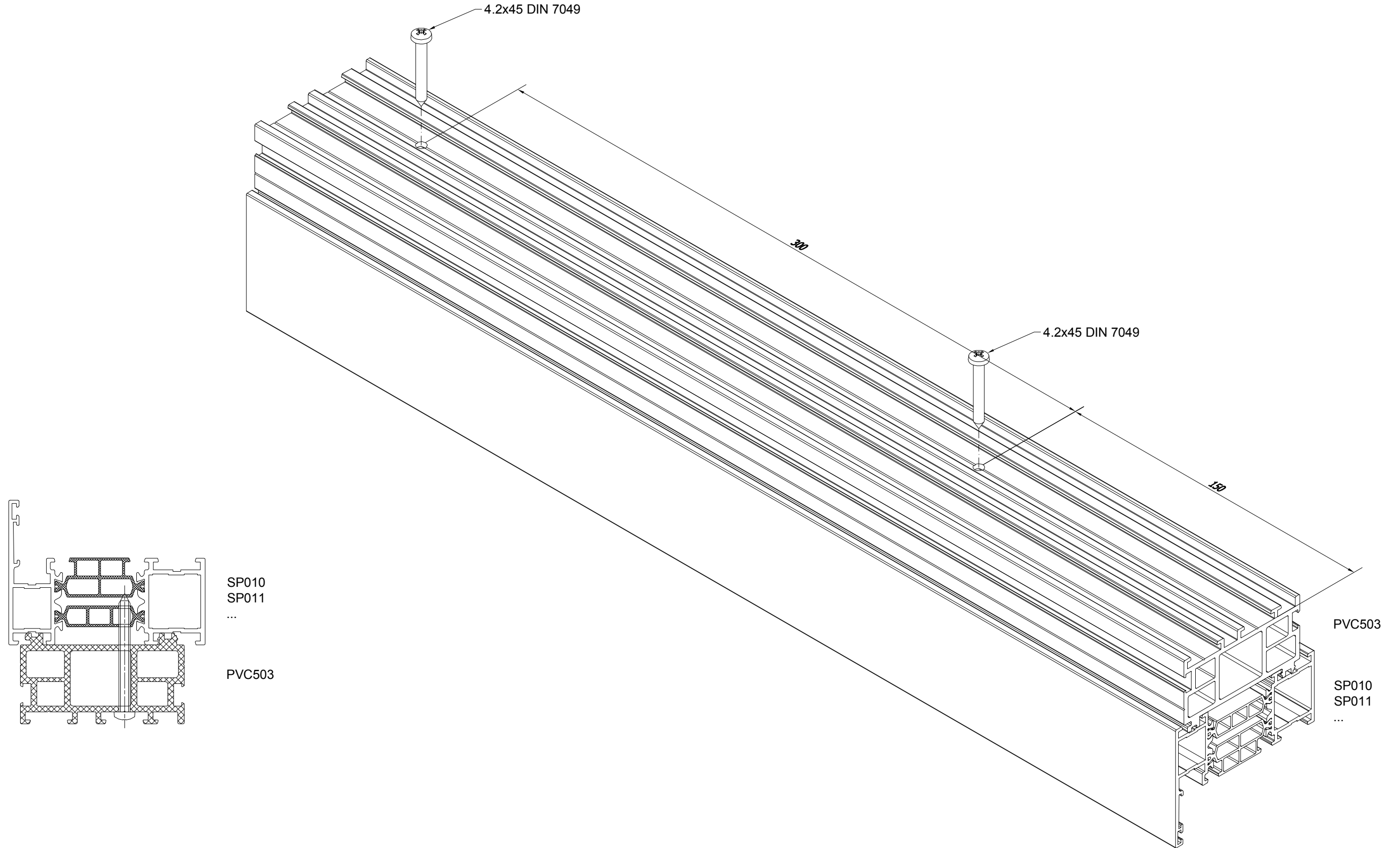

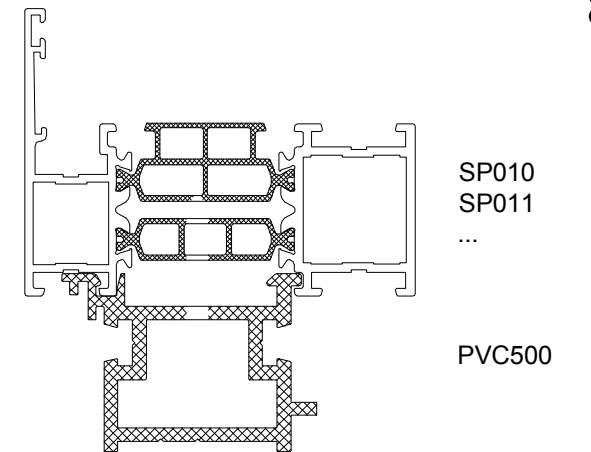
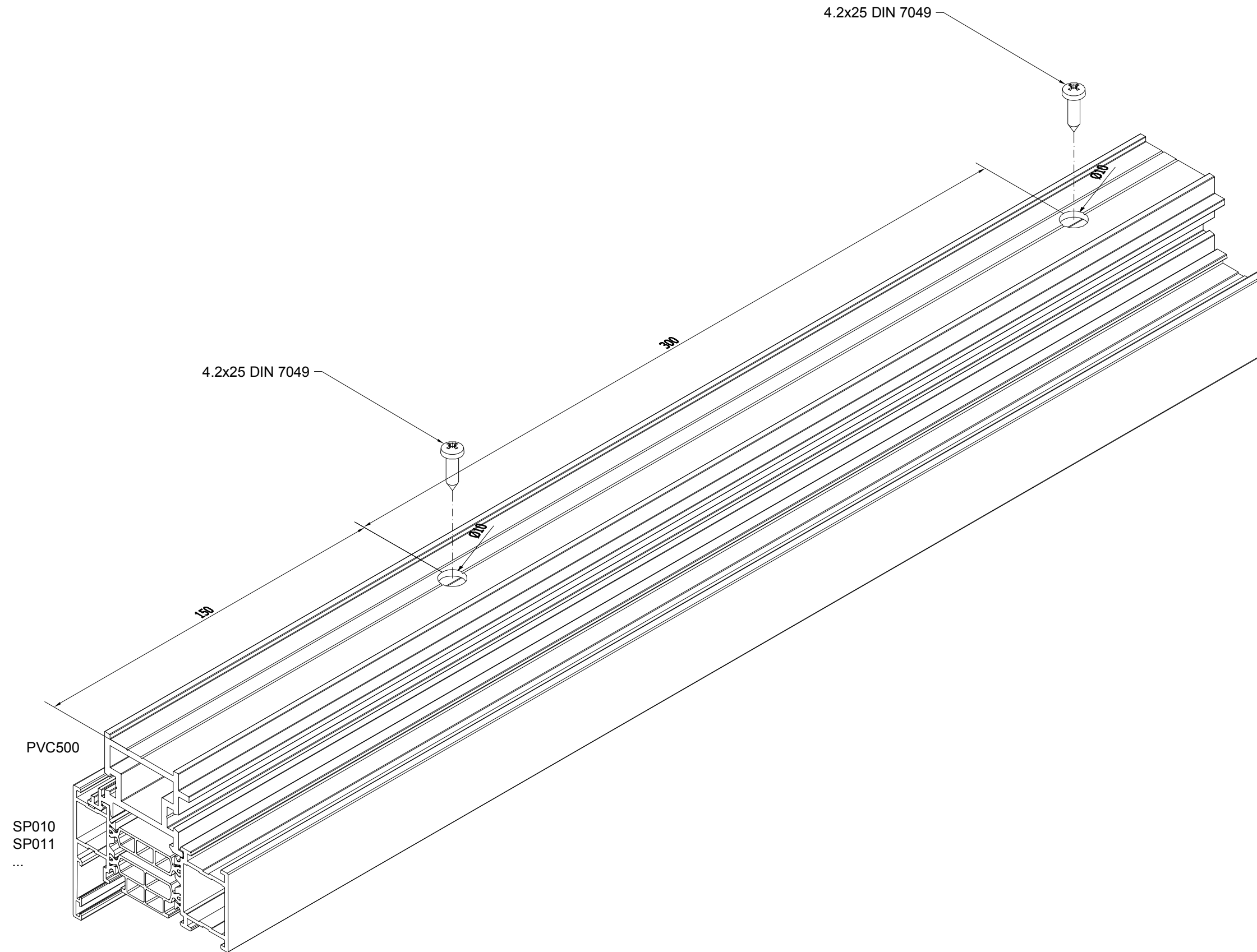

CONSTRUCTION DRAWINGS

# INSTALLATION SP

aliplast  
ALUMINIUM SYSTEMS

CONNECTION OUTERFRAME WITH UNDERPROFILE  
POŁĄCZENIE OŚCIEŻNICY Z PROFILEM PODOKIENNYM

CONSTRUCTION DRAWINGS

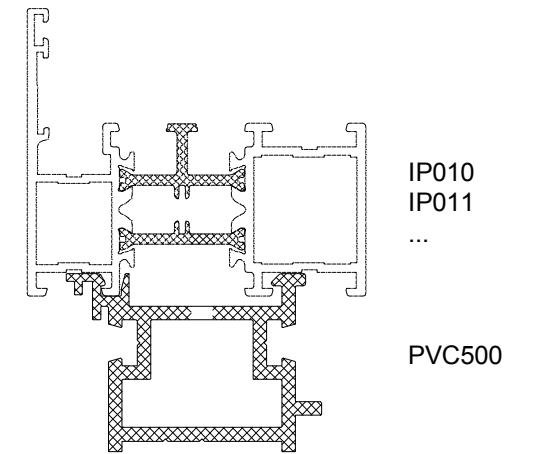
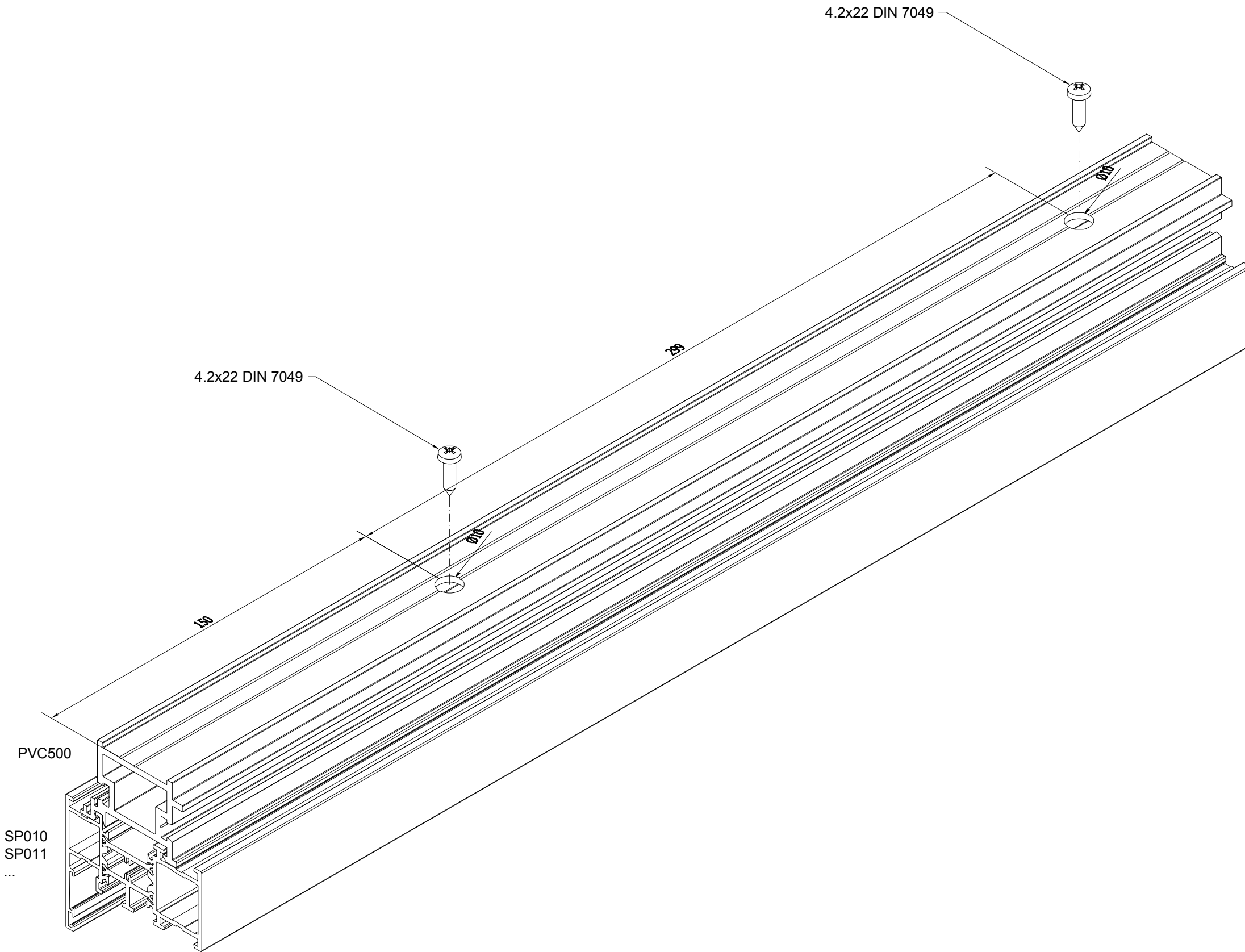

installation\_14\_06\_2017\_\_en

MO-F-024

16/6/2017

  
CORIALIS

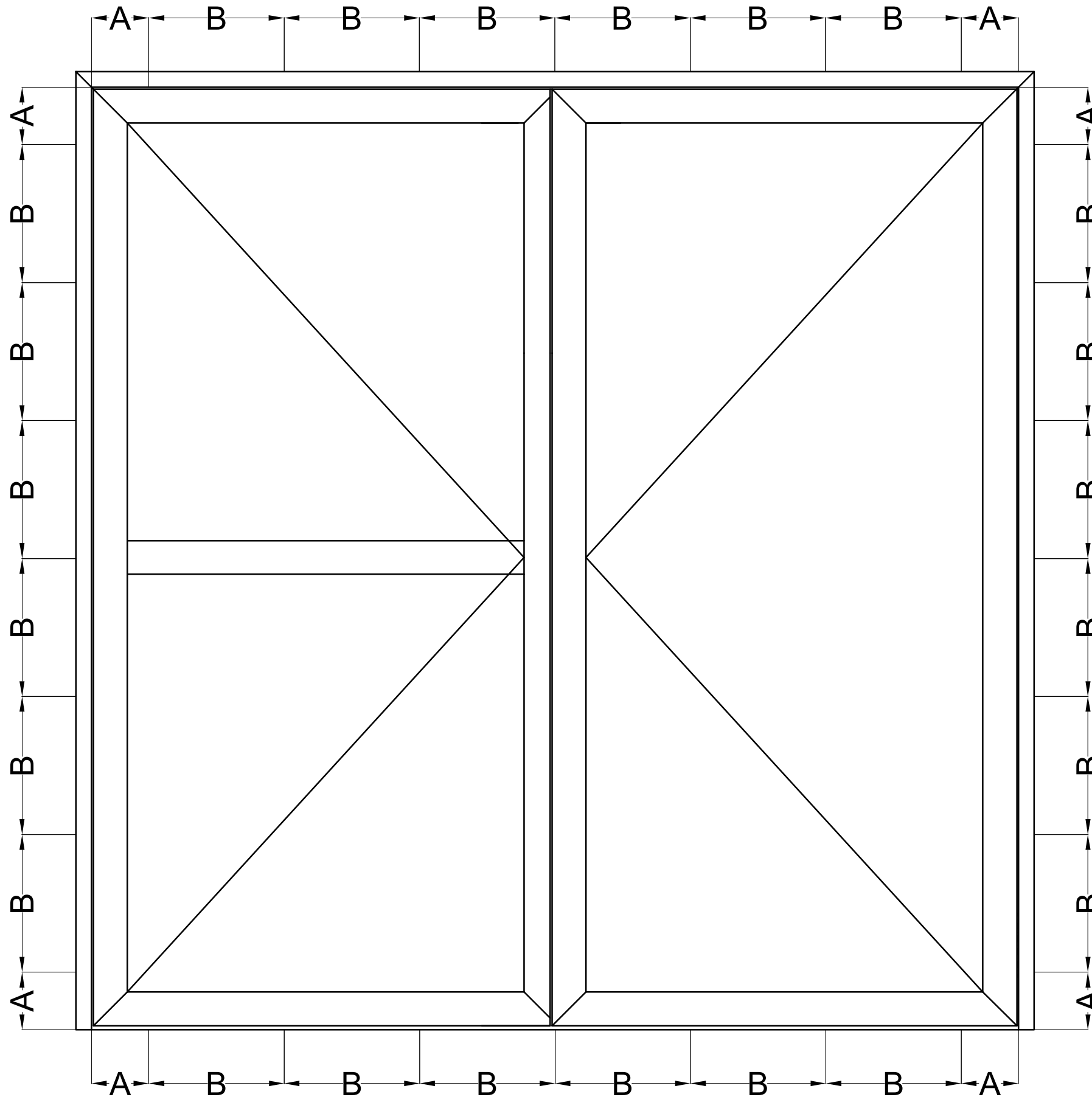

**A** - distance from inside corners frame  $\leq 150$  mm

**B** - distance between the dowels  $\leq 400$  mm

CONSTRUCTION DRAWINGS

# INSTALLATION

## IP800 - AW

CONSTRUCTION DRAWINGS

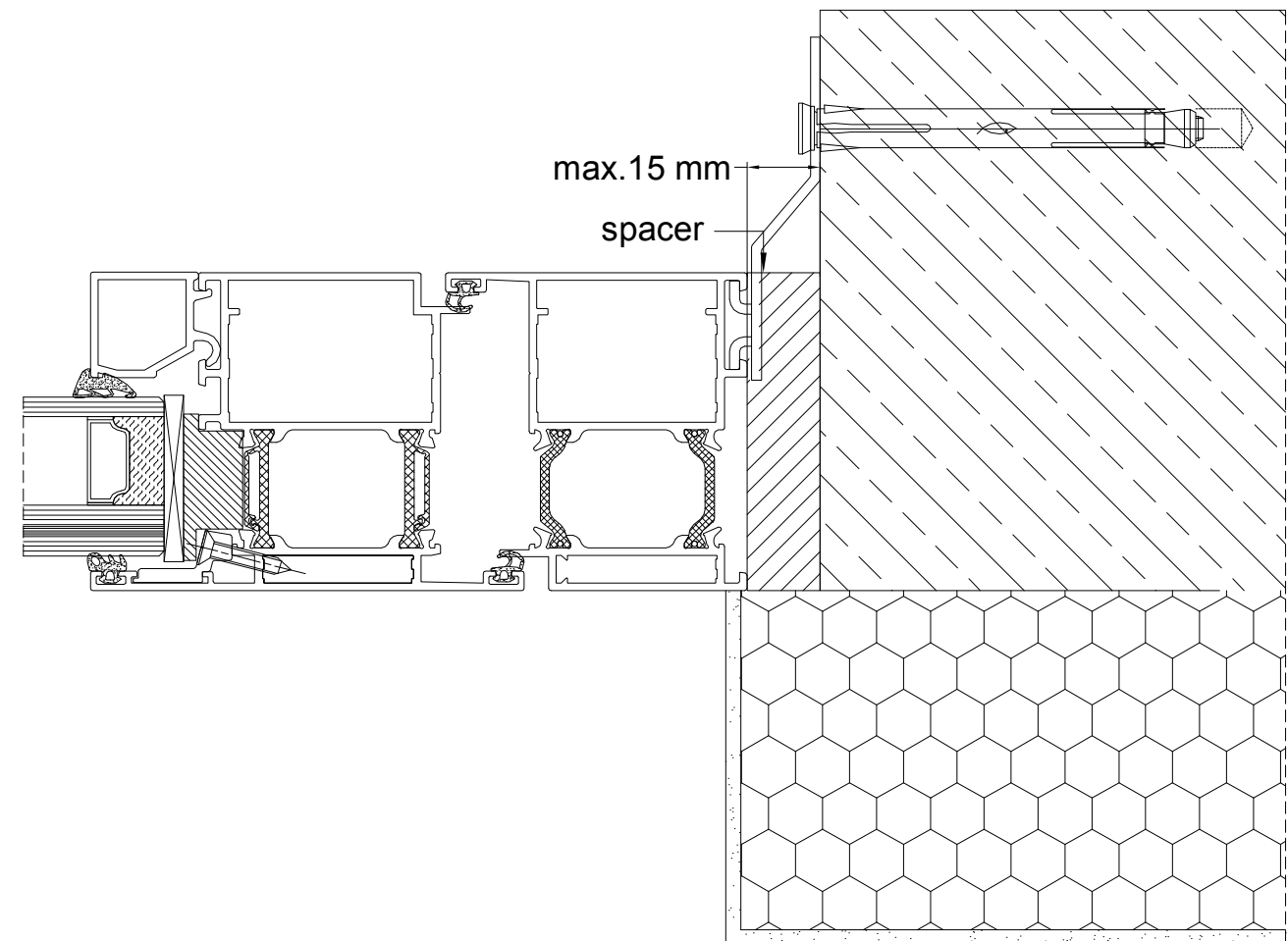
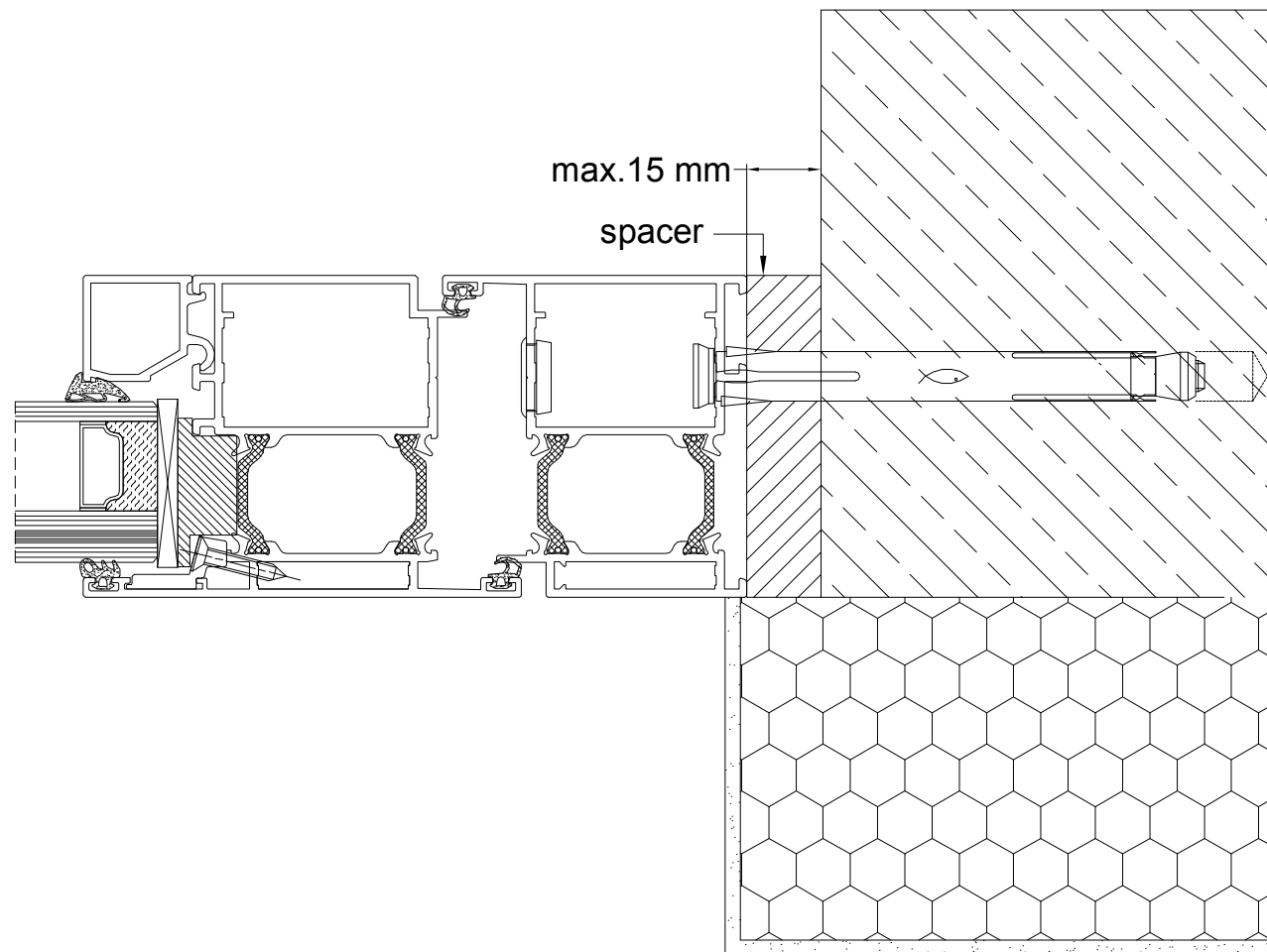

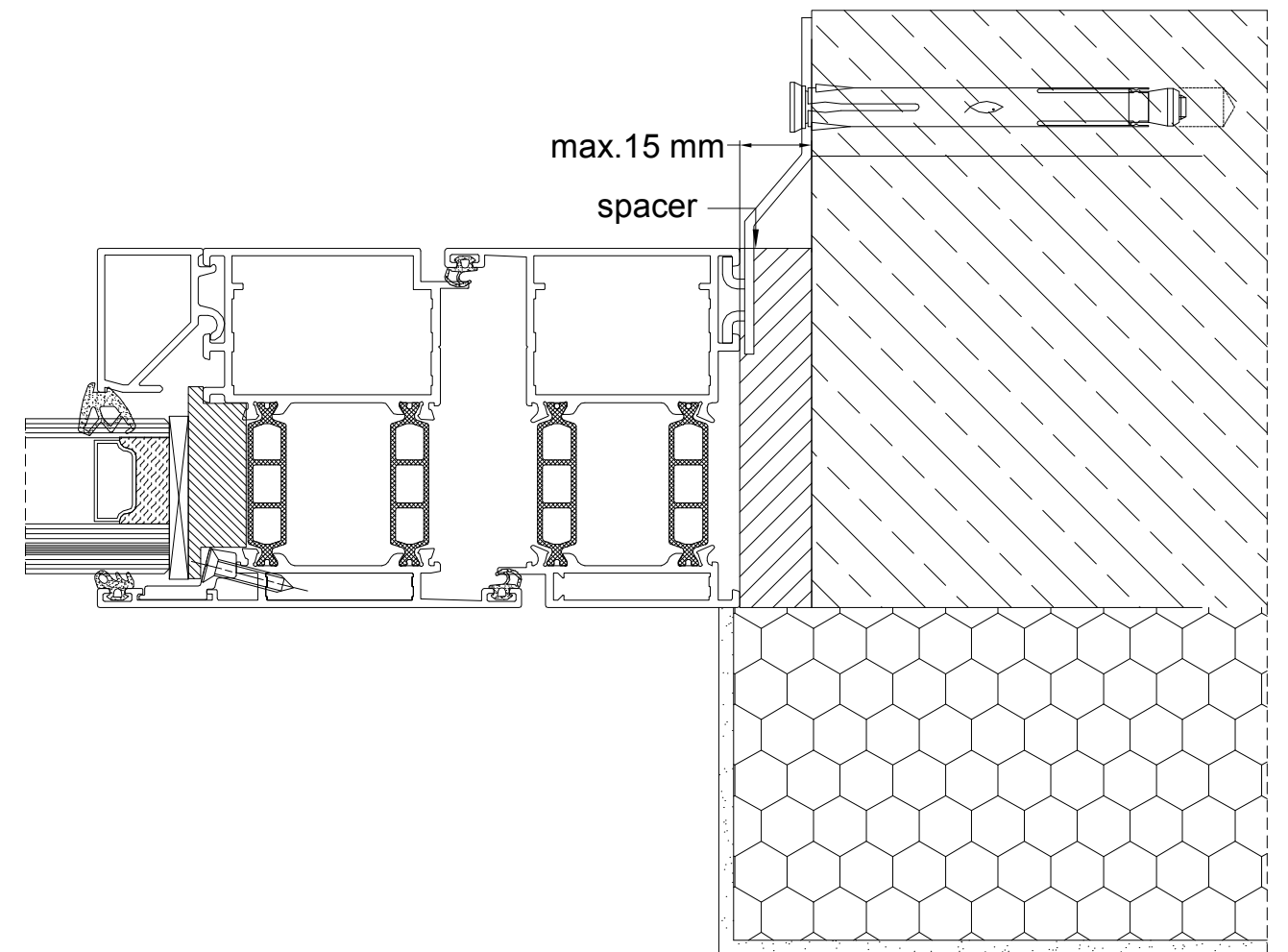
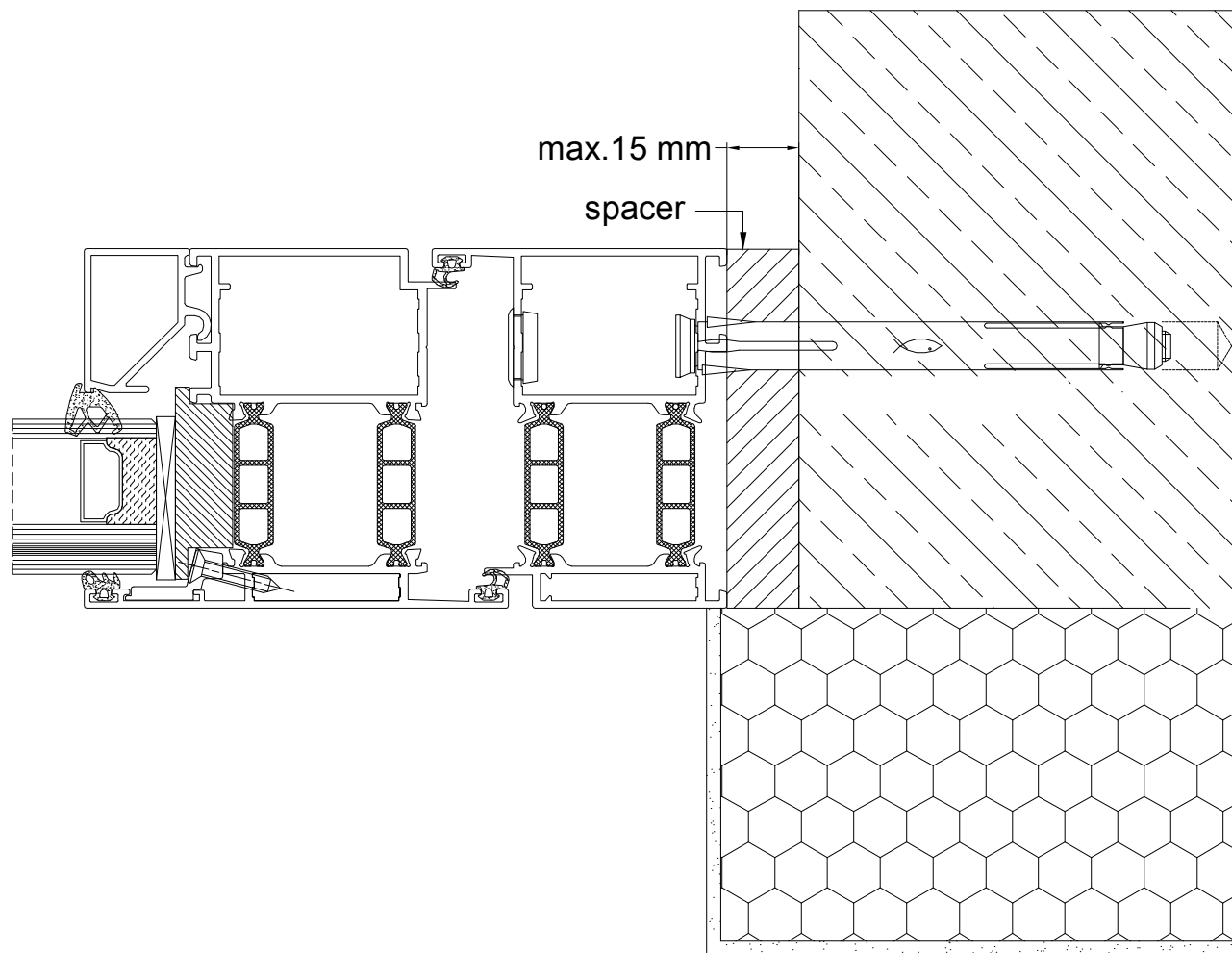

CONSTRUCTION DRAWINGS

# INSTALLATION

CONSTRUCTION DRAWINGS

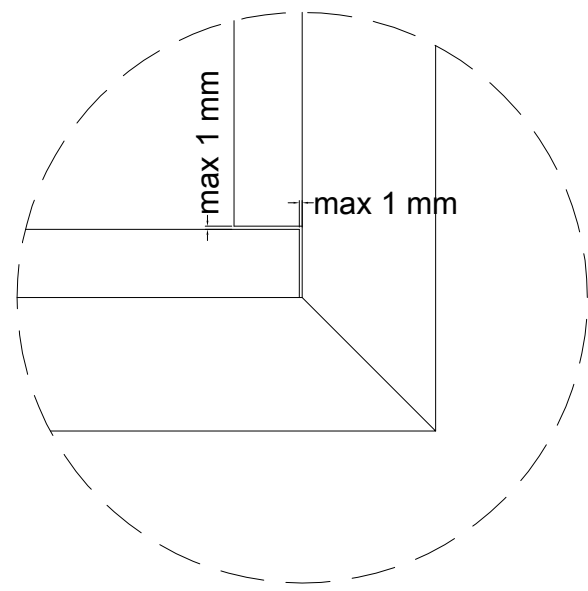
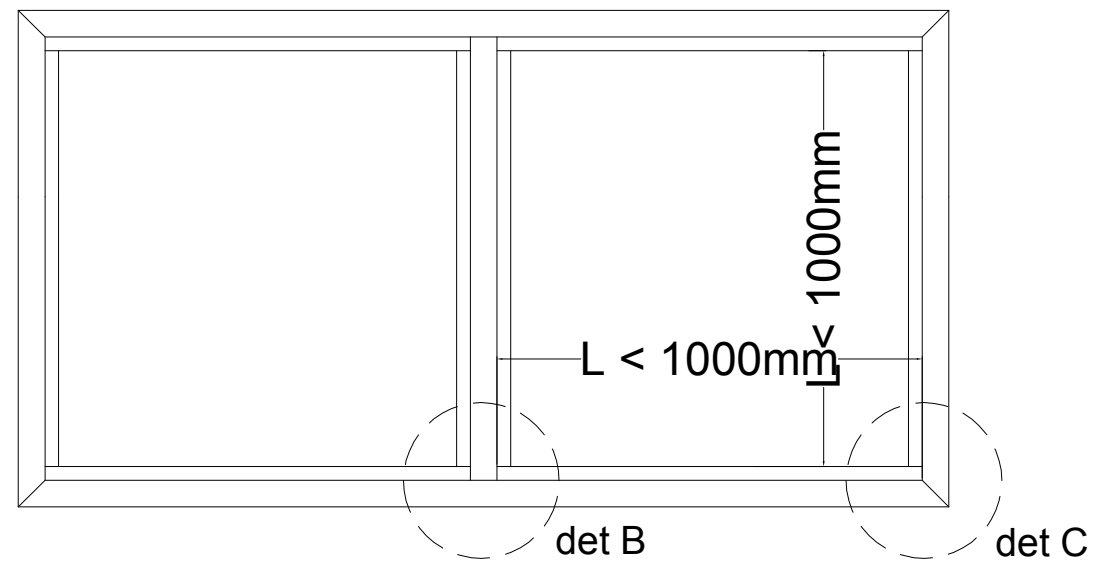
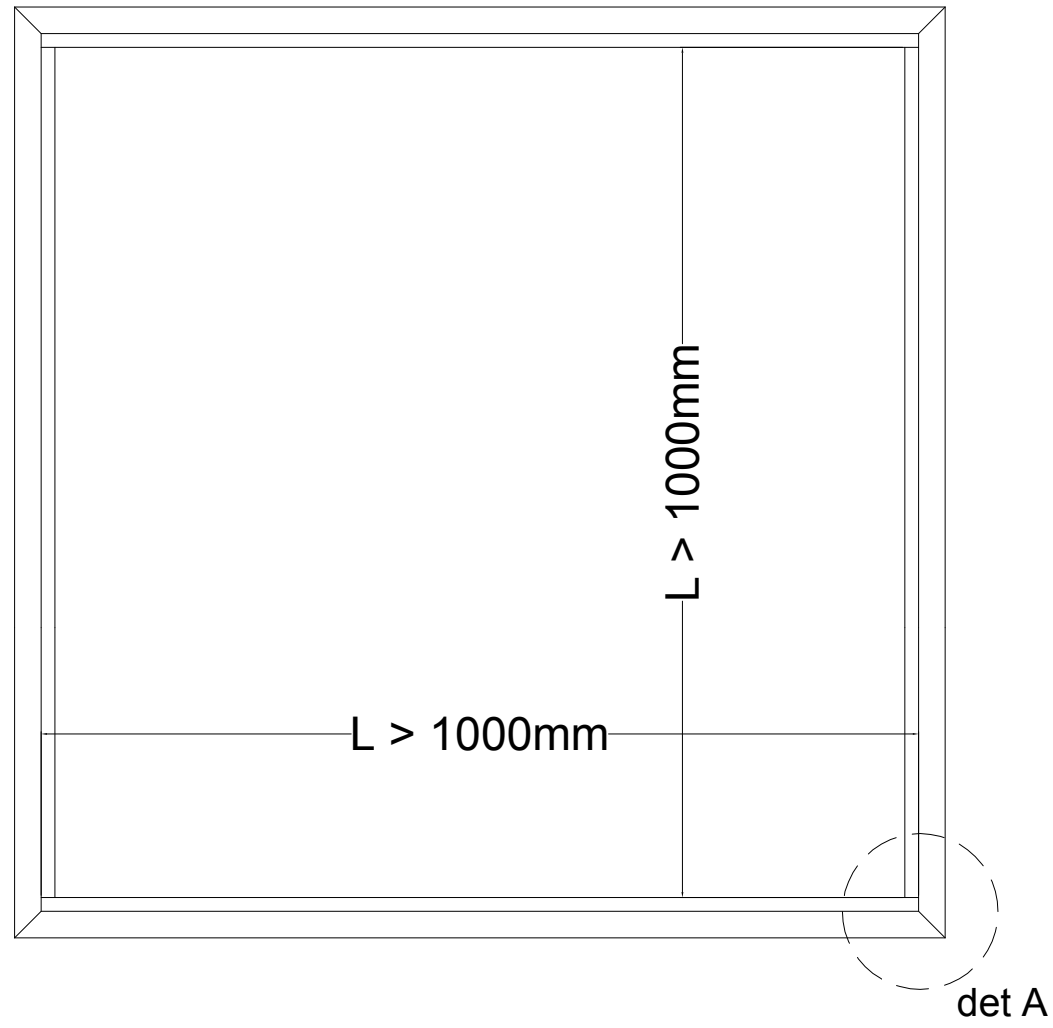

det A

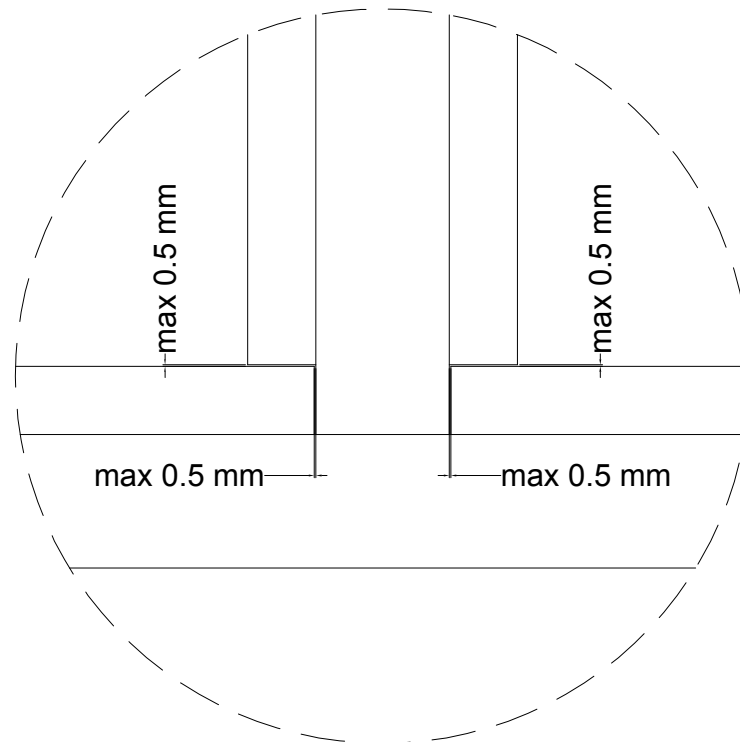

det B

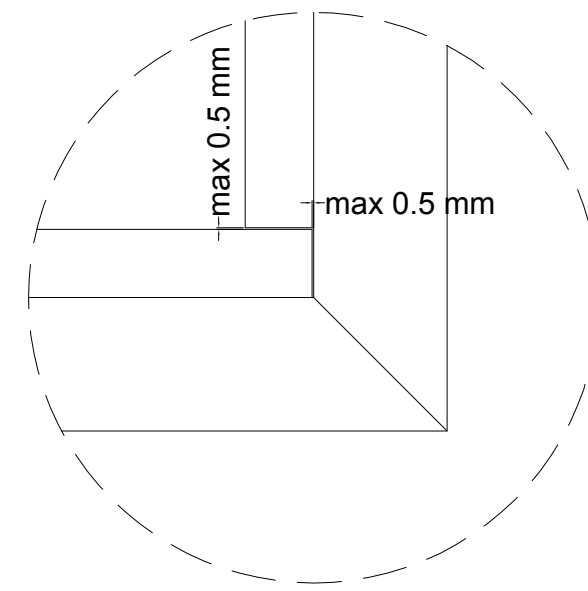

det C

installation\_windows\_&\_doors\_en

MO-F-028

22/9/2017



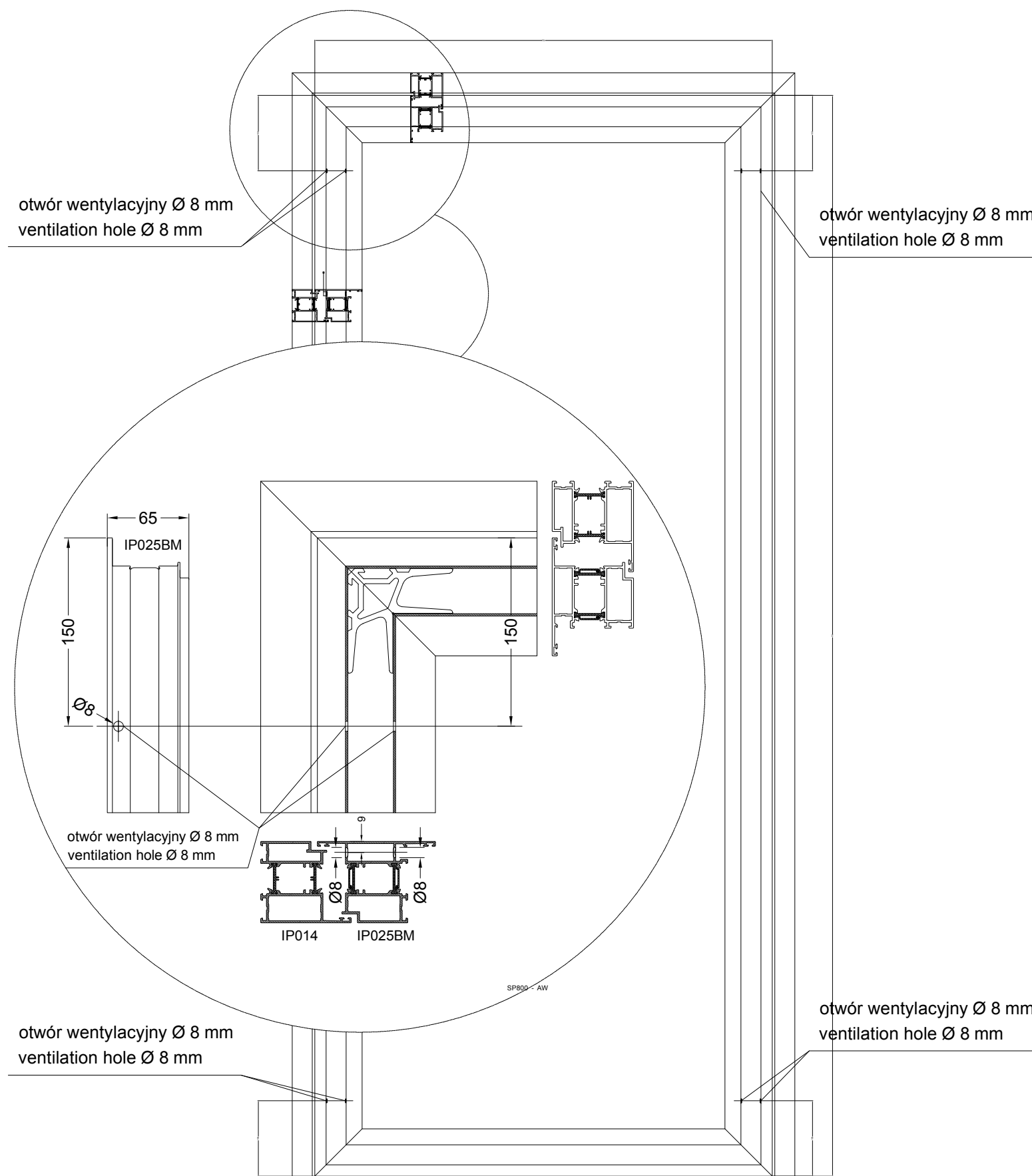

CONSTRUCTION DRAWINGS

## LOCATION CONTRUCTION PADS FOR HEAVY FILLING ABOVE 200KG AND DISTANCE PADS

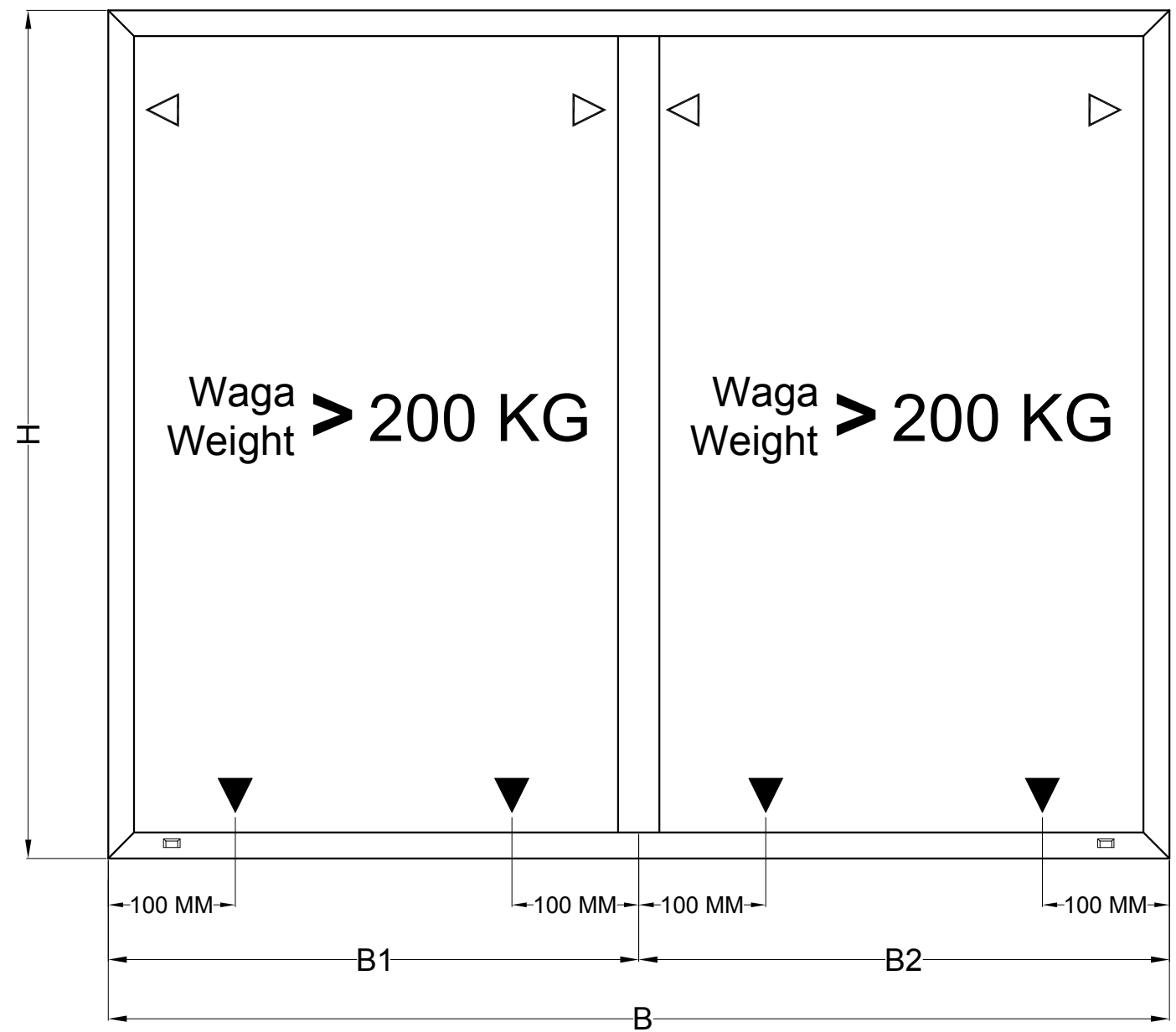
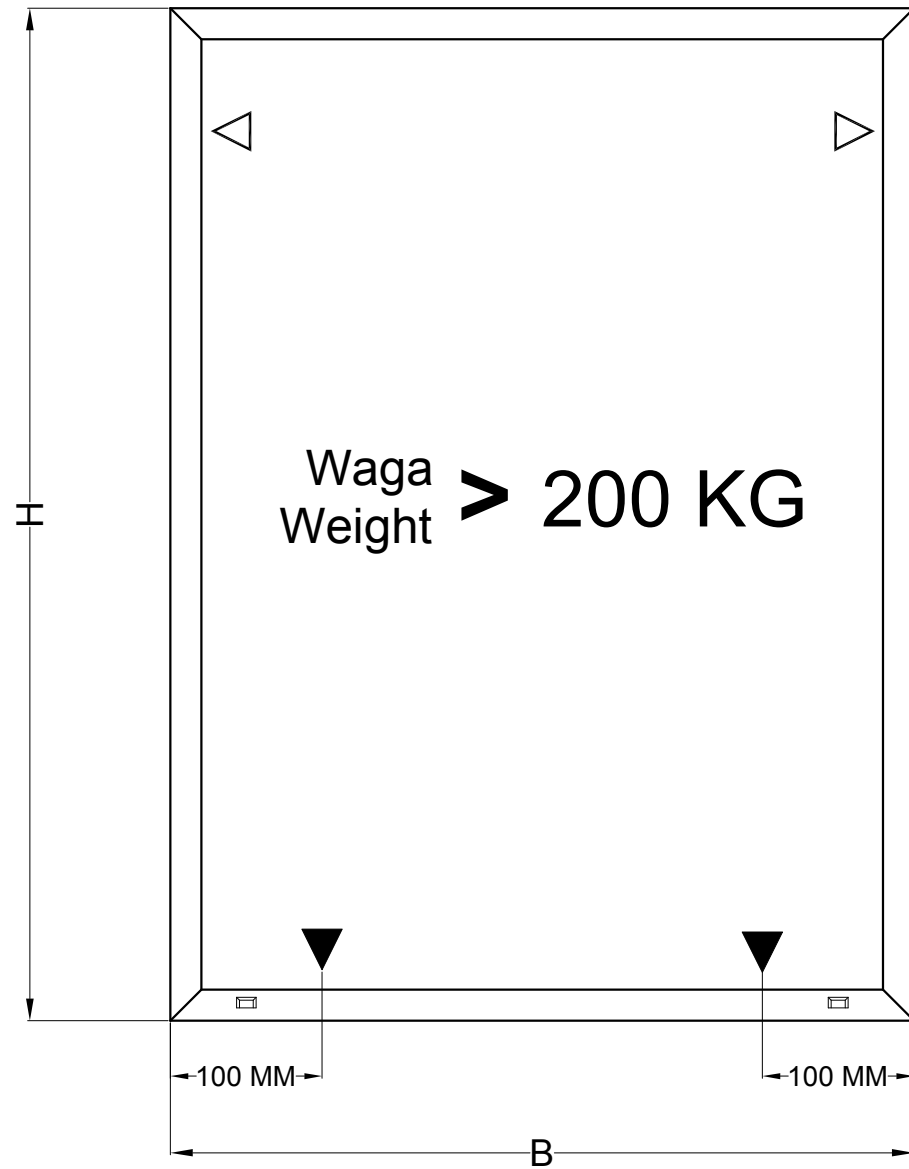

▼ = construction element for heavy filling (ALU)

▽ = distance element standard (PVC)

WERKTEKENINGEN - DESSINS DE CONSTRUCTION - KONSTRUKTIONZEICHNUNGEN - CONSTRUCTION DRAWINGS - RYS. KONSTRUKCYJNE

STRONA / PAGE

DATA / DATE

OPIS / DESCRIPTION

<b>07.09.2016</b>	
MO-F-001 - MO-F-007	Deleted pages
MO-F-001 - MO-F-015	Added pages
MO-F-017 - MO-F-024	Added pages

<b>09.12.2016</b>	
MO-F-025 - MO-F-027	Added pages

<b>14.09.2017</b>	
F-028	Added montage/dimensions for glazing beads

<b>02.10.2017</b>	
F-029, F-030	Added location of drainage holes & heavy pads (glass > 200 kg) drawings

**SUBJECT TO CHANGE BY ALIPLAST  
WITHOUT PRIOR NOTICE**